

Hitachi Unified Storage VM Block Module Hitachi SNMP Agent User Guide

FASTFIND LINKS

[Contents](#)

[Product Version](#)

[Getting Help](#)

© 2012-2013 Hitachi, Ltd. All right reserved.

No part of this publication may be reproduced or transmitted in any form or by any means, electronic or mechanical, including photocopying and recording, or stored in a database or retrieval system for any purpose without the express written permission of Hitachi, Ltd. (hereinafter referred to as "Hitachi"), and Hitachi Data Systems Corporation (hereinafter referred to as "Hitachi Data Systems").

Hitachi and Hitachi Data Systems reserve the right to make changes to this document at any time without notice and assume no responsibility for its use. This document contains the most current information available at the time of publication. When new or revised information becomes available, this entire document will be updated and distributed to all registered users.

All of the features described in this document may not be currently available. Refer to the most recent product announcement or contact your local Hitachi Data Systems sales office for information about feature and product availability.

Notice: Hitachi Data Systems products and services can be ordered only under the terms and conditions of Hitachi Data Systems' applicable agreements. The use of Hitachi Data Systems products is governed by the terms of your agreements with Hitachi Data Systems.

Hitachi is a registered trademark of Hitachi, Ltd., in the United States and other countries. Hitachi Data Systems is a registered trademark and service mark of Hitachi in the United States and other countries.

ShadowImage and TrueCopy are registered trademarks of Hitachi Data Systems.

AIX and IBM are registered trademarks or trademarks of International Business Machines Corporation.

All other trademarks, service marks, and company names are properties of their respective owners.

Microsoft product screen shots are reprinted with permission from Microsoft Corporation.



Contents

Preface	v
Intended audience	vi
Product version	vi
Document revision level	vi
Changes in this revision	vi
Referenced documents	vi
Conventions	vi
Convention for storage capacity values	vii
Accessing product documentation	viii
Getting help	viii
Comments	viii
1 Introduction	1-1
SNMP Manager overview	1-2
SNMP Manager and SNMP Agent interaction	1-2
Management Information base	1-3
SNMP Agent configuration	1-3
SNMP Agent functions	1-4
SNMP traps	1-4
SNMP Agent operations	1-5
Error report	1-5
Component status information from SNMP Manager	1-6
Resources that can be executed for each function	1-6
2 Using SNMP.	2-1
Managing SNMP IP addresses	2-2
Adding an SNMP Manager IP address	2-2
Deleting an SNMP Manager IP address	2-3
Managing community names	2-4
Adding a community name	2-4
Deleting a community name	2-5

Changing a community name	2-6
Managing community IP addresses	2-7
Adding a community IP address	2-7
Deleting a Community IP address	2-8
Testing the SNMP trap report	2-9
3 SNMP supported MIBs	3-1
Trap configuration	3-2
Failure report trap	3-2
Supported traps	3-2
Standard MIB specifications	3-3
Supported MIBs	3-3
MIB access mode	3-3
Object identifier system	3-3
MIB mounting specifications	3-4
Extension MIB specifications.	3-5
raidExMibName	3-5
raidExMibVersion	3-5
raidExMibAgentVersion.	3-5
raidExMibDkcCount	3-6
raidExMibRaidListTable.	3-6
raidExMibDKCHWTable.	3-7
raidExMibDKUHWTable.	3-8
raidExMibTrapListTable.	3-9
Extension MIB configuration.	3-10
4 SNMP failure trap reference.	4-1
SNMP failure trap reference codes.	4-2
5 Troubleshooting	5-1
Getting help	5-2
Solving SNMP problems	5-2
A SNMP GUI reference	A-1
SNMP Information window	A-2

Glossary

Index



Preface

This manual provides instructions and information to use the Hitachi SNMP Agent on the Hitachi Unified Storage VM (HUS VM).

This preface includes the following information.

- [Intended audience](#)
- [Product version](#)
- [Document revision level](#)
- [Changes in this revision](#)
- [Referenced documents](#)
- [Conventions](#)
- [Convention for storage capacity values](#)
- [Accessing product documentation](#)
- [Getting help](#)
- [Comments](#)

Intended audience

This document is intended for system administrators, HDS representatives, and authorized service providers who are involved in installing, configuring, and operating the Hitachi Unified Storage VM (HUS VM) storage system.

Readers of this document should be familiar with the following:

- A background in data processing and an understanding of RAID storage systems and their basic functions.
- Familiarity with the Hitachi Unified Storage VM storage system and the *Hitachi Unified Storage VM Block Module Hardware User Guide*.
- Familiarity with the Storage Navigator software for the Hitachi Unified Storage VM and the *Hitachi Storage Navigator User Guide*.
- Familiarity with the operating system and web browser software on the system hosting the Storage Navigator software.

Product version

This document revision applies to Hitachi Unified Storage VM microcode 73-03-0x and later.

Document revision level

Revision	Date	Description
MK-92HM7014-00	September 2012	Initial release.
MK-92HM7014-01	December 2012	Supersedes and replaces MK-92HM7014-00.
MK-92HM7014-02	March 2013	Supersedes and replaces MK-92HM7014-01.
MK-92HM7014-03	October 2013	Supersedes and replaces MK-92HM7014-02.

Changes in this revision

- Added trap reference codes to [Table 4-1 SNMP failure trap reference codes on page 4-2](#)

Referenced documents

Hitachi Unified Storage VM:





- *Hitachi Unified Storage VM Block Module Hardware User Guide*, MK-92HM7005

Conventions

This document uses the following typographic conventions:

Convention	Description
Bold	Indicates the following: <ul style="list-style-type: none"> Text in a window or dialog box, such as menus, menu options, buttons, and labels. Example: On the Add Pair dialog box, click OK. Text appearing on screen or entered by the user. Example: The -split option. The name of a directory, folder, or file. Example: The horcm.conf file.
<i>Italic</i>	Indicates a variable, which is a placeholder for actual text provided by the user or system. Example: copy <i>source-file</i> <i>target-file</i> Angle brackets are also used to indicate variables.
Monospace	Indicates text that is displayed on screen or entered by the user. Example: # pairdisplay -g oradb
< > angle brackets	Indicates a variable, which is a placeholder for actual text provided by the user or system. Example: # pairdisplay -g <group> Italic is also used to indicate variables.
[] square brackets	Indicates optional values. Example: [a b] indicates that you can choose a, b, or nothing.
{ } braces	Indicates required or expected values. Example: { a b } indicates that you must choose either a or b.
vertical bar	Indicates that you have a choice between two or more options or arguments. Examples: [a b] indicates that you can choose a, b, or nothing. { a b } indicates that you must choose either a or b.

This document uses the following icons to draw attention to information:

Icon	Meaning	Description
	Tip	Helpful information, guidelines, or suggestions for performing tasks more effectively.
	Note	Calls attention to additional information.
	Caution	Failure to take or avoid a specified action can result in adverse conditions or consequences (for example, loss of access to data).
	WARNING	Failure to take or avoid a specified action can result in severe conditions or consequences (for example, loss of data).

Convention for storage capacity values

Physical storage capacity values (for example, disk drive capacity) are calculated based on the following values:

Physical capacity unit	Value
1 KB	1,000 (10 ³) bytes
1 MB	1,000 KB or 1,000 ² bytes
1 GB	1,000 MB or 1,000 ³ bytes
1 TB	1,000 GB or 1,000 ⁴ bytes
1 PB	1,000 TB or 1,000 ⁵ bytes
1 EB	1,000 PB or 1,000 ⁶ bytes

Logical storage capacity values (for example, logical device capacity) are calculated based on the following values:

Logical capacity unit	Value
1 KB	1,024 (2 ¹⁰) bytes
1 MB	1,024 KB or 1,024 ² bytes
1 GB	1,024 MB or 1,024 ³ bytes
1 TB	1,024 GB or 1,024 ⁴ bytes
1 PB	1,024 TB or 1,024 ⁵ bytes
1 EB	1,024 PB or 1,024 ⁶ bytes

Accessing product documentation

The Unified Storage VM user documentation is available on the Hitachi Data Systems Portal: <https://portal.hds.com>. Check this site for the most current documentation, including important updates that may have been made after the release of the product.

Getting help

The Hitachi Data Systems customer support staff is available 24 hours a day, seven days a week. If you need technical support, log on to the Hitachi Data Systems Portal for contact information: <https://portal.hds.com>

Comments

Please send us your comments on this document: doc.comments@hds.com. Include the document title and number, including the revision level (for example, -07), and refer to specific sections and paragraphs whenever possible. All comments become the property of Hitachi Data Systems.

Thank you!

Introduction

This topic provides an overview of the SNMP implementation for monitoring the Hitachi Unified Storage VM, including the agent and management functions.

- [SNMP Manager overview](#)
- [SNMP Agent configuration](#)
- [Component status information from SNMP Manager](#)
- [Resources that can be executed for each function](#)

SNMP Manager overview

SNMP Manager is installed in the network management station. It collects and manages information from SNMP agents installed in the managed devices on the network. The SNMP Manager graphically displays information collected from two or more SNMP agents, accumulates the information in the database, and analyzes problems discovered while accumulating this information.

SNMP Manager and SNMP Agent interaction

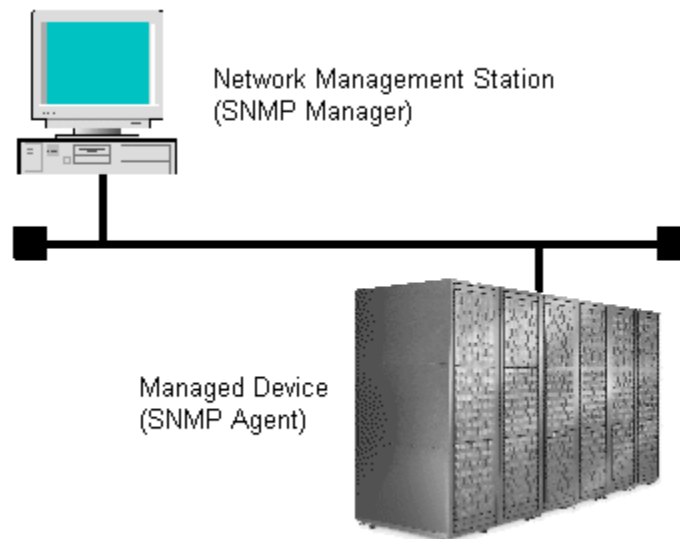

Figure 1-1 Example SNMP environment

Simple Network Management Protocol (SNMP) is an industry-standard protocol for managing and monitoring network devices, including disk devices, routers, and hubs. SNMP uses Simple Gateway Management Protocol (SGMP) to manage TCP/IP gateways.

An SNMP manager monitors the devices, which are referred to as managed nodes. Typically, an SNMP Manager polls the SNMP agents on a periodic basis. The manager receives the reports from the agents and determines whether the devices are operating normally. If an abnormal event occurs, an SNMP Agent can report the condition without a request from the manager, by using a trap message.

The network management station can collect the status (information) of all managed nodes. This information can be examined to determine if an abnormal event has occurred.

When an SNMP manager polls an agent, the following dialogue takes place:

- An SNMP Manager sends a request packet to an SNMP Agent, which requests data regarding the status of the managed node.
- The SNMP Agent sends a response packet back to the SNMP Manager.

- SNMP uses the TCP/IP User Datagram Protocol (UDP). If the SNMP Agent does not respond within a specified time period, the SNMP Manager re-sends the request packet. That time period is set by the system administrator, taking into account the network traffic and operation policy.
- If an SNMP Agent again does not respond to the resent packet, the SNMP Manager assumes that an error has occurred. Depending on the times set for polling and response, this can take several seconds.

If an SNMP Agent detects an abnormal event, it sends a trap to the SNMP Manager. However, if a trap is dropped in transmission, the SNMP Manager does not know that it was sent. For this reason, you should use both polling and traps to determine whether an abnormal event has occurred.

Management Information base

The standardized configuration and database of network management information is called a Management Information Base (MIB). A standard MIB is common to all SNMP interfaces. An extension MIB is defined by the particular managed device or protocol.

A MIB is a collection of standardized configuration and network management information that is contained in each device on the network. Each MIB contains a set of parameters called managed objects. Each managed object consists of a parameter name, one or more parameters, and a group of operations that can be executed with the object. The MIB defines the type of information that can be obtained from a managed device, and the device settings that can be controlled from a management system.

SNMP Agent configuration

The Hitachi Unified Storage VM SNMP Agent is installed on the SVP, which is the computer within the storage array that manages the storage system. The Unified Storage VM has an exclusive LAN for communications between a storage system and the SVP, and a separate LAN for SNMP. The configuration of each Network Management Station is determined by the type of SNMP Manager. [Figure 1-2 SNMP environment architecture on page 1-4](#) illustrates the SNMP environment. [Figure 1-3 Example of SNMP operations on page 1-4](#) shows an example of SNMP operations by using an SNMP Manager.

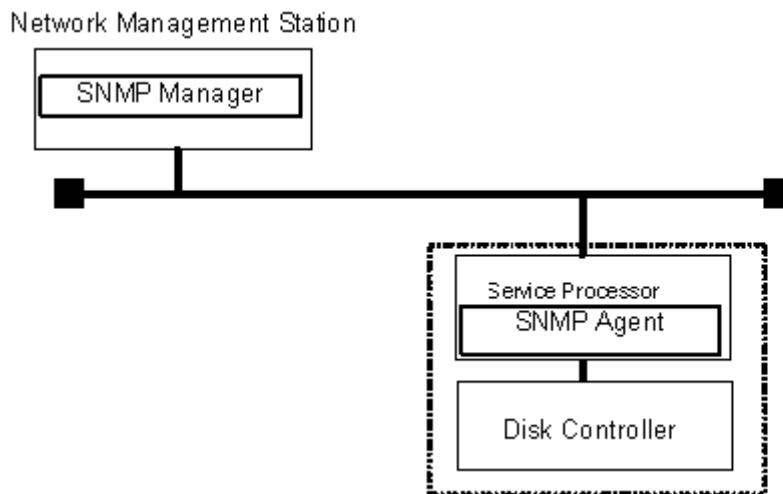

Figure 1-2 SNMP environment architecture

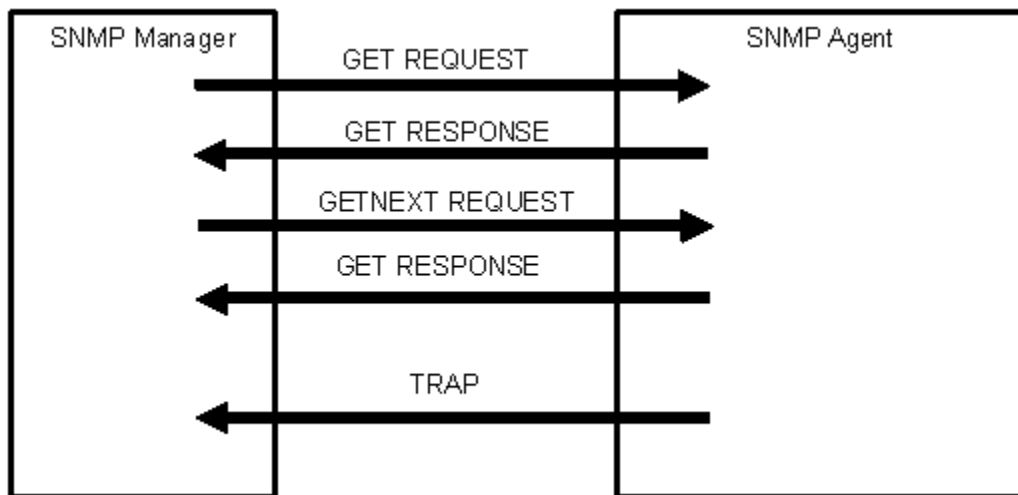

Figure 1-3 Example of SNMP operations

SNMP Agent functions

The SNMP Agent is mounted on the managed device (hard disk, etc.) in the network. It collects error information, the usage condition, and other information about the device, and forwards the information to the SNMP Manager. The SNMP Agent reports storage system failures to the manager using the functions described in the following paragraphs.

SNMP traps

An SNMP Agent uses the SNMP trap function to report a storage system error to the SNMP Manager. If an error occurs, an SNMP Agent issues an SNMP trap that reports the failure to an SNMP Manager. When issuing an SNMP trap, an SNMP Agent also reports a product number, nickname, reference code, and an identifier of the component.

The following table lists the events that trigger an SNMP Agent trap.

Table 1-1 SNMP Agent events

Events	Description
Acute failure detected.	All operations in a storage system stopped.
Serious failure detected.	Operation in a component where a failure occurred stopped.
Moderate failure detected.	Partial failure.
Service failure detected.	Minor failure.

An SNMP Agent logs the most recent 256 traps, so you can see the trap history of a particular device.

SNMP Agent operations

The following table lists the types of SNMP Agent operations.

Table 1-2 Types of SNMP Agent operations

Operation	Description
GET	Obtains a specific MIB object value. GET REQUEST is the request from an SNMP Manager, and GET RESPONSE is the agent's response to that request.
GETNEXT	Continuously finds a MIB object. GETNEXT REQUEST is the request from an SNMP Manager, and GETNEXT RESPONSE is the agent's response to that request.
TRAP	Reports an event (failure) to an SNMP Manager. TRAP occurs without a request from the SNMP Manager.

Error report

The following table lists the errors to be reported for the REQUEST operations.

Table 1-3 REQUEST operation errors

Error	Description	Corrective action
noError (0)	Normal	N/A
noSuchName (2)	<ul style="list-style-type: none"> There are no MIB objects that are required. (Not supported.) The GETNEXT REQUEST command that is specified for the following object identifier of the last supported MIB object is received. 	Verify that the name of the requested object is correct.
readOnly (4)	SET REQUEST is received.	SET operation is not supported.
genErr (5)	Error occurred for other reasons.	Retry the operation.

Component status information from SNMP Manager

You can obtain the status information of certain storage system components from the SNMP Manager. The following table lists the components for which the status can be obtained.

Table 1-4 Storage system components

Area	Component name
Storage System	Processors
	BUS
	Cache
	Shared memory
	Power supplies
	Batteries
	Fans
	Others
DB	Power supplies
	Fans
	Hard disks
	Others

The following table lists the status of storage system components, as well as the trap report functions.

Table 1-5 Storage system component status

Status	Description
Normal	Normal operation.
Acute failure detected	All operations in a storage system stopped.
Serious failure detected	Operation in a component where a failure occurred stopped.
Moderate failure detected	Partial failure.
Service failure detected	Minor failure.

Resources that can be executed for each function

Storage Navigator secondary window shows all the resources in the storage system. However, the functions described in this manual are only available to the resources that are assigned to a user account who logs into the Storage Navigator. Verify the resource group ID in the Basic Information Display dialog boxes, and then execute the operations for the resources assigned to the user account. When you use the functions, the resources for each operation must satisfy the specific conditions.

For details on user accounts, see *Hitachi Storage Navigator User Guide*. For details on the conditions of the resources, see the *Hitachi Unified Storage VM Block Module Provisioning Guide*.

Using SNMP

This topic describes how to use Storage Navigator to manage SNMP Manager IP addresses, community names, and community IP addresses. It also explains how to test SNMP trap reports.

- [Managing SNMP IP addresses](#)
- [Managing community names](#)
- [Managing community IP addresses](#)
- [Testing the SNMP trap report](#)

Managing SNMP IP addresses

Adding an SNMP Manager IP address

Prerequisite: You must have Storage Administrator privileges to perform this task.

1. Launch Storage Navigator and log in.
2. In the Storage Navigator main window, click **Settings** > **Environmental Setting** > **SNMP Information** in the Storage Navigator menu bar. The **SNMP Information** window appears.

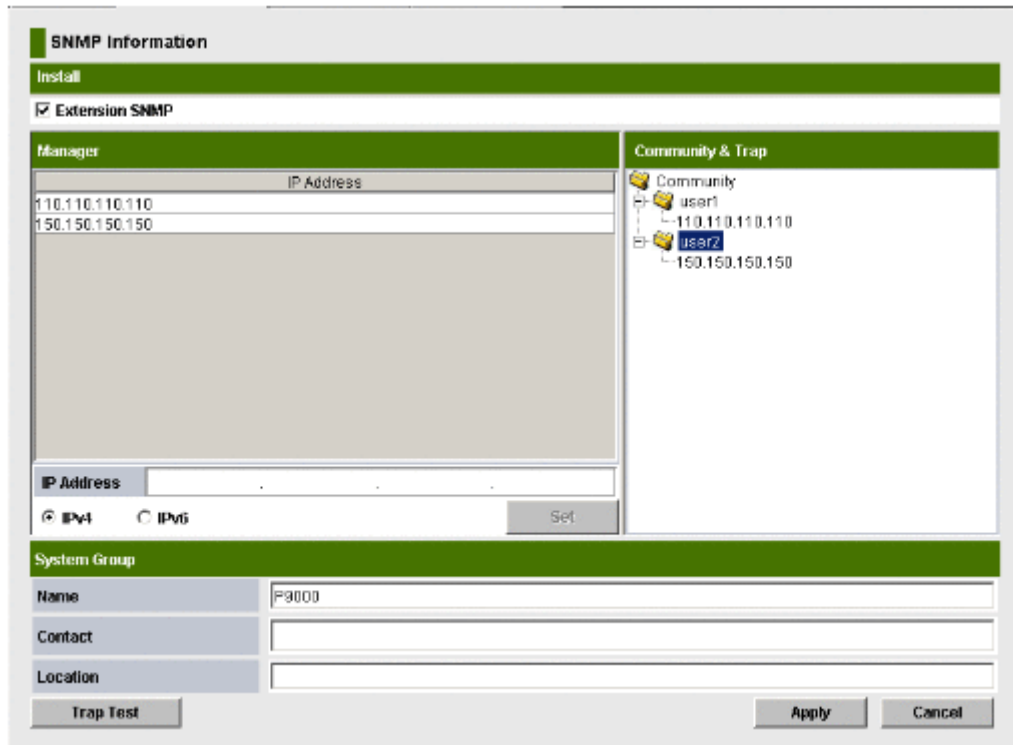

3. Click the Mode Change icon () to change to **Modify** mode.
4. In the SNMP Information window, click **Extension SNMP**.
5. Select **IPv4** or **IPv6** and specify the version of the IP address you enter.



Note: In SVP, Windows does not support IPv6. If the SVP OS is Windows and you enter the IPv6 address and click **Apply**, an error message is displayed and the IPv6 address is not set.

6. Enter the desired IP address in the **IP Address** text box.

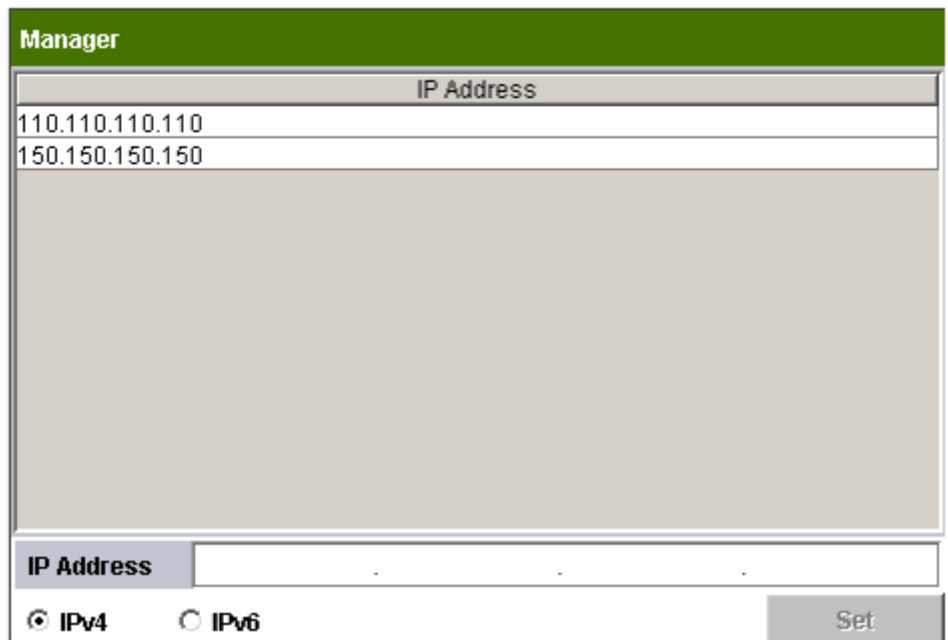

7. Click **Set**. The new IP address is added to the **IP Address** list, but the changes are not yet saved.
8. Click **Apply** to save the changes. A confirmation message is displayed.
9. In the confirmation message box, click **OK** to confirm the changes or **Cancel** to exit without saving the changes.

Deleting an SNMP Manager IP address

Prerequisite: You must have Storage Administrator privileges to perform this task.

1. Launch Storage Navigator and log in.
2. Click the Mode Change icon () to change to **Modify** mode.
3. In the Storage Navigator main window, click **Settings** > **Environmental Setting** > **SNMP Information** in the menu bar. The **SNMP Information** window is displayed.
4. In the **SNMP Information** window, click **Extension SNMP** (check box).
5. In the **IP Address** list box, select one or more unwanted IP addresses. Right-click the IP address to display the **Delete IP Address** menu.

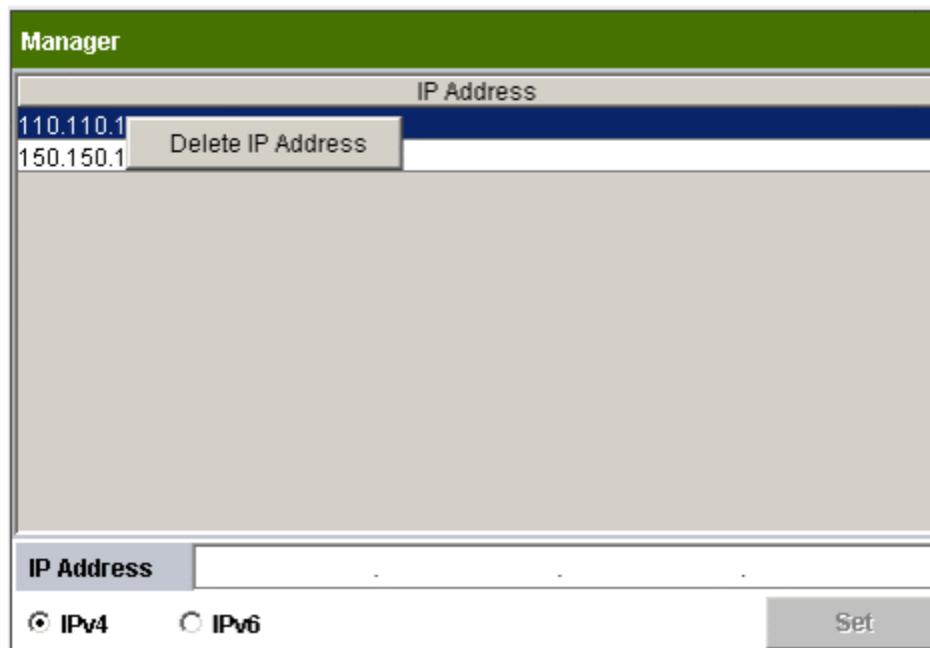

6. Click **Delete IP Address**.
7. A confirmation message is displayed. Select **OK** to delete the IP address, or **Cancel** to exit the dialog box without deleting the IP address.
8. In the **SNMP Information** window, click **Apply** to save the changes. A confirmation message is displayed.
9. In the confirmation message box, click **OK** to confirm the changes or click **Cancel** to exit without saving the changes.

Managing community names

Adding a community name

Prerequisite: You must have Storage Administrator privileges to perform this task.

1. Launch Storage Navigator and log in.
2. In the Storage Navigator menu bar, click **Settings > Environmental Setting > SNMP Information**. The **SNMP Information** window is displayed.
3. Click the Mode Change icon () to change to **Modify** mode.
4. In the **SNMP Information** window, click **Extension SNMP** (check box). The **Community & Trap** dialog box is displayed.
5. In the **Community & Trap** dialog box, right-click **Community**. The **Add Community** menu is displayed.
6. Select **Add Community**. The **Add Community** dialog box is displayed.

- In the **Community** field, enter the desired community name. You can enter up to 180 alphanumeric characters. The following special characters are not allowed: ", \, ;, :, , , *, ?, <, >, |, /, ^, &, and %.

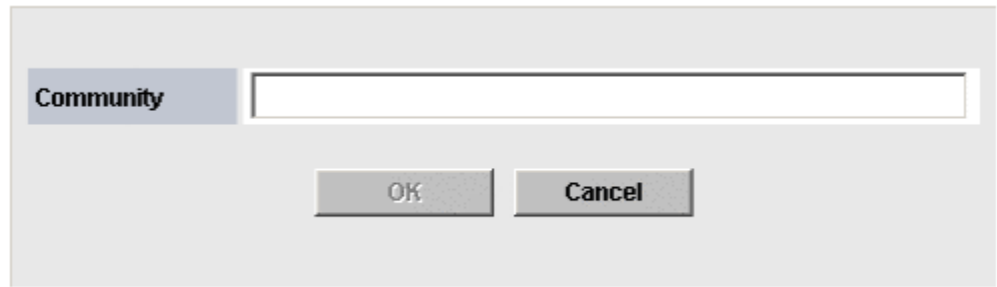

- Click **OK**. The new community name is displayed in the **Community & Trap** dialog box, but the changes are not yet implemented in the storage system.
- To add one or more IP addresses to the new community, see [Adding a community name on page 2-4](#).
- Click **Apply** to save the changes. A confirmation message is displayed.
- In the confirmation message box, click **OK** to confirm the changes or **Cancel** to exit without saving the changes.

Deleting a community name

Prerequisite: You must have Storage Administrator privileges to perform this task.

- Launch Storage Navigator and log in.
- In the Storage Navigator menu bar, click **Settings > Environmental Setting > SNMP Information**. The **SNMP Information** window is displayed.
- Click the Mode Change icon () to change to **Modify** mode.
- In the **SNMP Information** window, click **Extension SNMP** (check box). The **Community & Trap** dialog box is displayed.
- In the **Community & Trap** dialog box, right-click **Community**. The **Delete Community** menu is displayed.



- Select **Delete Community**. A confirmation message is displayed.

7. Click **OK**. The selected community is deleted from the **Community & Trap** list, but the settings are not yet saved.
8. Click **Apply** to save the changes. A confirmation message is displayed.
9. In the confirmation message box, click **OK** to confirm the changes or **Cancel** to exit without saving the changes.

Changing a community name

Prerequisite: You must have Storage Administrator privileges to perform this task.

1. Launch Storage Navigator and log in.
2. In the Storage Navigator menu bar, click **Settings > Environmental Setting > SNMP Information**. The **SNMP Information** window is displayed.
3. Click the Mode Change icon () to change to **Modify** mode.
4. In the **SNMP Information** window, click **Extension SNMP** (check box).
5. In the **Community & Trap** dialog box, select and then right-click the community name that you want to change. The **Change Community** menu is displayed.



6. Select **Change Community**. The **Change Community** dialog box is displayed.

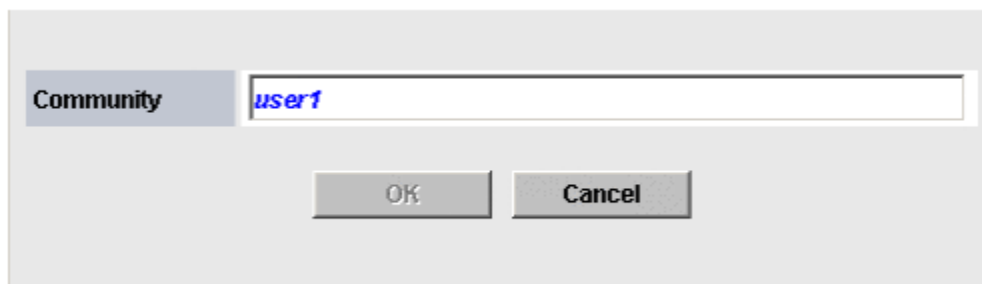

7. In the **Community** field, overwrite the old community name with a new community name. You can use up to 180 alphanumeric characters, except for ", \, ;, :, ,, *, ?, <, >, |, /, ^, &, and %.
8. Click **OK**. The changed community name is displayed in the **Community & Trap** dialog box, but the changes are not yet saved.

9. Click **Apply** to save the changes. A confirmation message is displayed.
10. In the confirmation message box, click **OK** to confirm the changes or **Cancel** to exit without saving the changes.

Managing community IP addresses

Adding a community IP address

This section describes the procedure to add a community IP address:

Prerequisite: You must have Storage Administrator privileges to perform this task.

1. Launch Storage Navigator and log in.
2. In the Storage Navigator menu bar, click **Settings > Environmental Setting > SNMP Information**. The **SNMP Information** window is displayed.
3. Click the Mode Change icon () to change to **Modify** mode.
4. In the **SNMP Information** window, click **Extension SNMP** (check box). The **Community & Trap** dialog box is displayed.
5. In the **Community & Trap** dialog box, right-click the desired community. The **Add Community** menu is displayed.
6. Select **Add IP Address**. The **Add IP Address** dialog box is displayed.



7. In the **IP Address** field, enter a new IP address or select an existing IP address.
 - o If the values for an IP address are all set to zero (0), then that address cannot be specified for IPv4 and IPv6.
 - o The **Add IP Address** dialog box does not support shortened expression of the IPv6 address. Enter 8 hexadecimal numbers that are separated by colons (:) to a maximum 4 digits from zero (0) to FFFF inclusive.

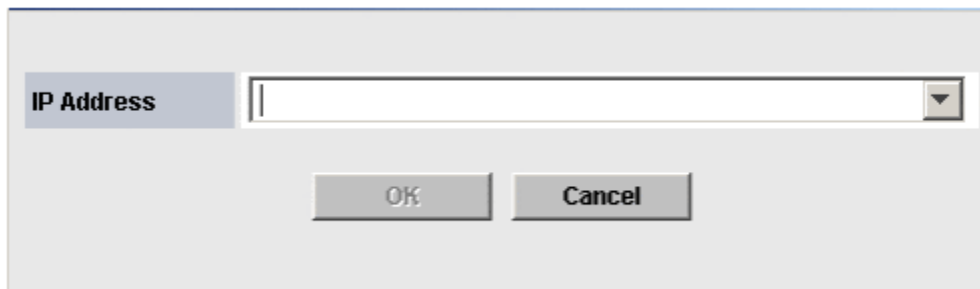

Note: In SVP, Windows does not support IPv6. If the SVP OS is Windows XP and you enter the IPv6 address and click **Apply**, an error message is displayed and the IPv6 address is not set.

8. Click **OK**. The changed community name is displayed in the **Community & Trap** dialog box, but the changes are not yet saved.
9. Click **Apply** to save the changes. A confirmation message is displayed.
10. In the confirmation message box, click **OK** to confirm the changes or **Cancel** to exit without saving the changes.

Deleting a Community IP address

Prerequisite: You must have Storage Administrator privileges to perform this task.

1. Launch Storage Navigator and log in.
2. In the Storage Navigator menu bar, click **Settings > Environmental Setting > SNMP Information**. The **SNMP Information** window is displayed.
3. Click the Mode Change icon () to change to **Modify** mode.
4. In the **SNMP Information** window, click **Extension SNMP** (check box). The **Community & Trap** dialog box is displayed.
5. In the **Community & Trap** dialog box, select the unwanted community IP address. Right-click to display the **Delete IP Address** menu.
6. Select **Delete IP Address**. A confirmation message is displayed.
7. Click **OK**. The changed community name is deleted from the **Community & Trap** dialog box, but the changes are not yet saved.
8. Click **Apply** to save the changes. A confirmation message is displayed.
9. In the confirmation message box, click **OK** to confirm the changes or **Cancel** to exit without saving the changes.



Testing the SNMP trap report

Prerequisite: You must have Storage Administrator privileges to perform this task.

1. Launch Storage Navigator and log in.
2. In the Storage Navigator menu bar, click **Settings > Environmental Setting > SNMP Information**. The **SNMP Information** window is displayed.
3. Click the Mode Change icon () to change to **Modify** mode.
4. In the SNMP Information window, click **Extension SNMP** (check box). The **Community & Trap** dialog box is displayed.
5. Select **Trap Test**. A confirmation message is displayed.
6. Select **OK**. Verify whether the SNMP trap report (reference code 7FFFFF) is received by the SNMP manager registered in the community.

SNMP supported MIBs

This topic describes the standard and extension MIB specifications, the SNMP GUI, and trap configuration.

- [Trap configuration](#)
- [Supported traps](#)
- [Standard MIB specifications](#)
- [Extension MIB specifications](#)
- [Extension MIB configuration](#)

Trap configuration

Failure report trap

An extension trap protocol data unit (PDU) includes the product number of the device that experienced the failure, the device nickname, and a failure reference code. If you obtain the information with `GetRequest` command, access the MIB by using the product number of the device as an index. The following table shows the failure report trap.

Table 3-1 Failure report trap

Name	Object identifier	Type	Description
eventTrapSerialNumber	.1.3.6.1.4.1.116.5.11.4.2.1	INTEGER	The product number of the device that experienced the failure.
eventTrapNickname	.1.3.6.1.4.1.116.5.11.4.2.2	DisplayString	The device nickname.
eventTrapREFCODE	.1.3.6.1.4.1.116.5.11.4.2.3	DisplayString	The failure reference
eventTrapPartsID	.1.3.6.1.4.1.116.5.11.4.2.4	OBJECT IDENTIFIER	The area where the failure occurred.*
eventTrapDate	.1.3.6.1.4.1.116.5.11.4.2.5	DisplayString	Failure occurrence date.
eventTrapTime	.1.3.6.1.4.1.116.5.11.4.2.6	DisplayString	Failure occurrence time.
eventTrapDescription	.1.3.6.1.4.1.116.5.11.4.2.7	DisplayString	Detailed information of a failure.

*The object identifier for a failure in a storage system processor would be .1.3.6.1.4.1.116.5.11.4.1.1.6.1.2.

Supported traps

The following table lists the supported extension trap types.

Table 3-2 Extension trap types

Specific Trap Code	Trap	Description
1	RaidEventUserAcute	All operations in a storage system stopped.
2	RaidEventUserSerious	Operation in a component where a failure occurred stopped.
3	RaidEventUserModerate	Partial failure.
4	RaidEventUserService	Minor failure.

Standard MIB specifications

Supported MIBs

The following table lists the supported MIBs. If you send a GET request for an object (MIB) that is not supported, you will receive *NoSuchName* as a GET RESPONSE.

Table 3-3 Supported MIBs

MIB		Supported?
Standard MIB: MIB-II	system group	Yes
	interface group	No
	at group	No
	ip group	No
	icmp group	No
	tcp group	No
	udp group	No
	egg group	No
snmp group	No	
Extension MIB		Yes

MIB access mode

The access mode for MIB in all communities is read only. If you send a GET request for a SET operation, you will receive *NoSuchName* as a GET RESPONSE.

An example object system supported by an SNMP Agent is shown the following figures.

Object identifier system

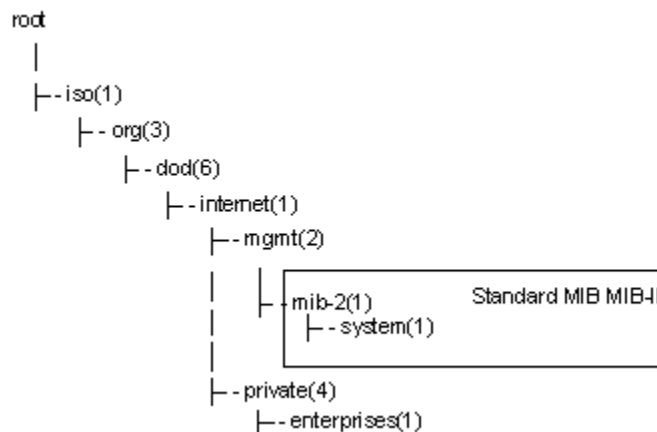

Figure 3-1 Object system (1)

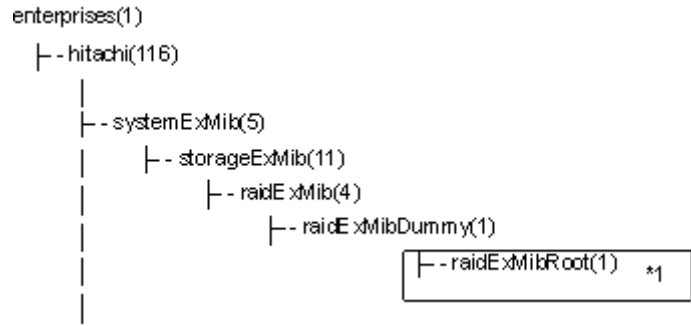

Figure 3-2 Object system (2)

*1: The HUS VM SNMP extended MIB

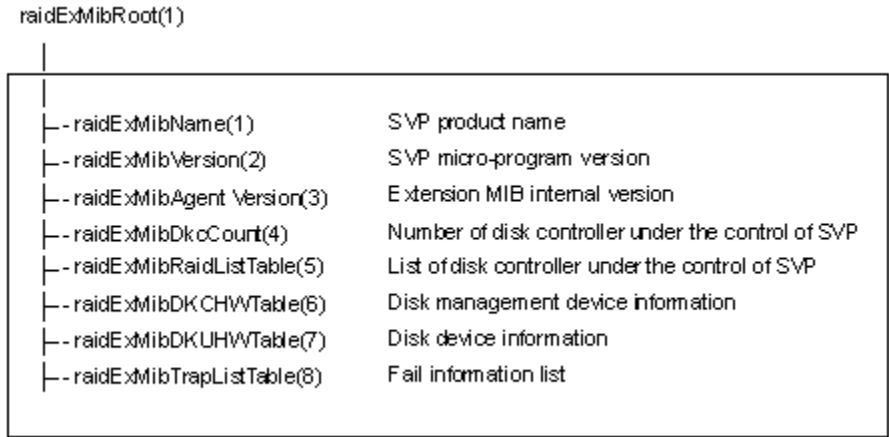

Figure 3-3 Object system (3)

MIB mounting specifications

The supported MIB mounting specifications are as follows:

- mgmt OBJECT IDENTIFIER ::= {iso(1) org(3) dod(6) internet(1) 2 }
- mib-2 OBJECT IDENTIFIER ::= {mgmt 1}

An SNMP Agent mounts only system groups in mib-2, as shown in the following.

Table 3-4 System groups

Name	Description	Mounted value
sysObjectID {system 2}	This is the product identification number.	Fixed value. See Object identifier system on page 3-3 . 1.3.6.1.4.1.116.3.11.4.1.1
sysUpTime {system 3}	An accumulated time from an SNMP agent.	Unit: ms
sysContact {system 4}	A manager who manages an agent or a contact address.	Maximum 180 characters in an ASCII characters string. Input by a user from an SNMP setting window.*

Name	Description	Mounted value
sysName {system 5}	The name of an agent manager	Maximum 180 characters in an ASCII characters string. Input by a user from an SNMP setting window.*
sysLocation {system 6}	An agent setup location.	Maximum 180 characters in an ASCII characters string. Input by a user from an SNMP setting window.*
sysService {system 7}	Value indicating a service.	Fixed value 76 (decimal)
*The following symbols cannot be used: \, / ; * ? " < > & % ^		

Extension MIB specifications

The following shows the Extension MIB configuration.

```
raidExMibRoot(1)
|--raidExMibName(1)          SVP product name
|--raidExMibVersion(2)      SVP Micro-program version
|--raidExMibAgentVersion(3) Extension MIB internal version
|--raidExMibDkcCount(4)     Number of DKC under the control of SVP
|--raidExMibRaidListTable(5) List of DKC under the control of SVP
|--raidExMibDKCHWTable(6)   Disk control device information
|--raidExMibDKUHWTable(7)   Disk device information
|--raidExMibTrapListTable(8) Error information list
```

raidExMibName

raidExMibName indicates the SVP product name.

```
raidExMibName          OBJECT-TYPE
    SYNTAX              DisplayString
    ACCESS               read-only
    STATUS               mandatory
    DESCRIPTION         "SVP product name."
    OID                 ::= { raidExMibRoot 1 }
```

raidExMibVersion

raidExMibVersion indicates the micro-program version.

```
raidExMibAgentVersion  OBJECT-TYPE
    SYNTAX              DisplayString
    ACCESS               read-only
    STATUS               mandatory
    DESCRIPTION         "SVP micro-program version."
    OID                 ::= { raidExMibRoot 2 }
```

raidExMibAgentVersion

raidExMibAgentVersion indicates the internal version of the extension MIB.

```

raidExMibDkcCount      OBJECT-TYPE
    SYNTAX              INTEGER
    ACCESS              read-only
    STATUS              mandatory
    DESCRIPTION         "Extension agent version."
    OID                 ::= { raidExMibRoot 3 }

```

raidExMibDkcCount

raidExMibDkcCount suggests the number of a storage system under the control of the SVP.

```

raidExMibDkcCount      OBJECT TYPE
    SYNTAX              INTEGER
    ACCESS              read-only
    STATUS              mandatory
    DESCRIPTION         "Registered subsystem number"
    OID                 ::= { raidExMibRoot 4 }

```

raidExMibRaidListTable

raidExMibRaidListTable indicates the storage system under the control of the SVP.

```

raidExMibRaidListTable OBJECT TYPE
    SYNTAX              SEQUENCE OF raidExMibRaidListEntry
    ACCESS              not-accessible
    STATUS              mandatory
    DESCRIPTION         "List of DKC which is registered
                        on the SVP."
    ::= { raidExMibRoot 5 }

raidExMibRaidListEntry OBJECT TYPE
    SYNTAX              RaidExMibRaidListEntry
    ACCESS              not-accessible
    STATUS              mandatory
    DESCRIPTION         "Entry of DKC list."
    INDEX               { raidlistSerialNumber }
    ::= { raidExMibRaidListTable 1 }

```

The following table lists the information displayed for each storage system

Table 3-5 Storage system information

Name	Type	Description	Mounted value	Attribute
raidlistSerialNumber ::=RaidExMibRaidListEntry(1)	INTEGER	Storage system product number (index).	200,001-299,999	read-only
raidlistMibNickName ::=RaidExMibRaidListEntry(2)	DisplayString	Storage system nickname.	(Max. 18 characters)	read-only

Name	Type	Description	Mounted value	Attribute
raidlistDKCMainVersion ::=RaidExMibRaidListEntry(3)	DisplayString	Microcode version.	Max. 10 characters	read-only
raidlistDKCProductName ::=RaidExMibRaidListEntry(4)	DisplayString	Storage system product type.	7 characters (1)	read-only
Note: HM700 will be used as storage system product type raidlistDKCProductName.				

raidExMibDKCHWTable

raidExMibDKCHWTable indicates the status of the storage system components.

```

raidExMibDKCHWTable OBJECT TYPE
SYNTAX SEQUENCE OF RaidExMibDKCHWEntry
ACCESS not-accessible
STATUS mandatory
DESCRIPTION "Error information of the DKC."
::={ raidExMibRoot 6}

raidExMibDKCHWEntry OBJECT TYPE
SYNTAX RaidExMibDKCHWEntry
ACCESS not-accessible
STATUS mandatory
DESCRIPTION "Entry of DKC information."
INDEX {dkcRaidListIndexSerialNumber}
::={ raidExMibDKCHWTable 1}

```

Table 3-6 Storage system component information

Name	Type	Description	MIB value	Attribute
dkcRaidListIndexSerialNumber ::=raidExMibDKCHWEntry(1)	INTEGER	Storage system product number (index).	200,001-299,999	read-only
dkcHWProcessor ::=raidExMibDKCHWEntry(2)	INTEGER	Status of processor.	See Note	read-only
dkcHWCSW ::=raidExMibDKCHWEntry(3)	INTEGER	Status of internal star.	See Note	read-only
dkcHWCache ::=raidExMibDKCHWEntry(4)	INTEGER	Status of cache.	See Note	read-only
dkcHWSM ::=raidExMibDKCHWEntry(5)	INTEGER	Status of shared memory.	See Note	read-only

Name	Type	Description	MIB value	Attribute
dkcHWPS ::=raidExMibDKCHWEntry(6)	INTEGER	Status of power supply.	See Note	read-only
dkcHWBattery ::=raidExMibDKCHWEntry(7)	INTEGER	Status of battery.	See Note	read-only
dkcHWFan ::=raidExMibDKCHWEntry(8)	INTEGER	Status of fan.	See Note	read-only
dkcHWEEnvironment ::=raidExMibDKCHWEntry(9)	INTEGER	Information of an operational environment.	See Note	read-only
<p>Note: The status of each component is a single digit which shows the following: 1: Normal. 2: Acute failure detected. 3: Serious failure detected. 4: Moderate failure detected. 5: Service failure detected.</p>				

raidExMibDKUHWTable

raidExMibDKUHWTable indicates the status of the storage system components.

```

raidExMibDKUHWTable OBJECT TYPE
SYNTAX                SEQUENCE OF RaidExMibDKUHWEntry
ACCESS                not-accessible
STATUS                mandatory
DESCRIPTION           "Error information of the DKU."
::={ raidExMibRoot 7}

raidExMibDKUHWEntry  OBJECT TYPE
SYNTAX                RaidExMibDKUHWEntry
ACCESS                not-accessible
STATUS                mandatory
DESCRIPTION           "Entry of DKU information."
INDEX                 { dkuRaidListIndexSerialNumber }
::={ raidExMibDKUHWTable 1}

```

Table 3-7 Disk device components information

Name	Type	Description	MIB value	Attribute
dkuRaidListIndexSerialNumber ::=raidExMibDKUHWEntry(1)	INTEGER	Storage system product number (index).	200,001-299,999	read-only

Name	Type	Description	MIB value	Attribute
dkuHWPS ::=raidExMibDKUHWEEntry(2)	INTEGER	Status of power supply.	See Note	read-only
dkuHWFan ::=raidExMibDKUHWEEntry(3)	INTEGER	Status of fan.	See Note	read-only
dkuHWEEnvironment ::=raidExMibDKUHWEEntry(4)	INTEGER	Status of environment monitor.	See Note	read-only
dkuHWDrive ::=raidExMibDKUHWEEntry(5)	INTEGER	Status of drive.	See Note	read-only
<p>Note: The status of each component is a single digit which shows the following: 1: Normal. 2: Acute failure detected. 3: Serious failure detected. 4: Moderate failure detected. 5: Service failure detected.</p>				

raidExMibTrapListTable

raidExMibTrapListTable shows the history of the failure traps.

```

raidExMibTrapListTable OBJECT TYPE
SYNTAX SEQUENCE OF RaidExMibTrapListEntry
ACCESS not-accessible
STATUS mandatory
DESCRIPTION "Trap list table."
::={ raidExMibRoot 8 }
raidExMibTrapListEntry OBJECT TYPE
SYNTAX RaidExMibTrapListEntry
ACCESS non-accessible
STATUS mandatory
DESCRIPTION "Trap list table index."
INDEX { eventListIndexSerialNumber ,
eventListIndexRecordNo }
::={ raidExMibTrapListTable 1 }

```

Table 3-8 Failure information

Name	Type	Description	MIB value	Attribute
eventListIndexSerialNumber ::=raidExMibTrapListEntry(1)	INTEGER	Storage system product number (index)	200,001-299,999	read-only

Name	Type	Description	MIB value	Attribute
eventListNickname ::=raidExMibTrapListEntry (2)	DisplayString	Storage system nickname	18 characters maximum	read-only
eventListIndexRecordNo ::=raidExMibTrapListEntry (3)	Counter	Number of records	1-256	read-only
eventListREFCODE ::=raidExMibTrapListEntry (4)	DisplayString	Reference code	6 characters	read-only
eventListData ::=raidExMibTrapListEntry (5)	DisplayString	Date when the failure was occurred	yyyy/mm/dd (10 characters)	read-only
eventListTime ::=raidExMibTrapListEntry (6)	DisplayString	Time when the failure occurred	hh:mm:ss (8 characters)	read-only
eventListDescription ::=raidExMibTrapListEntry (7)	DisplayString	Detailed information about the failure	256 characters maximum	read-only

Extension MIB configuration

Following figures show extension MIB configurations (1) and (2).

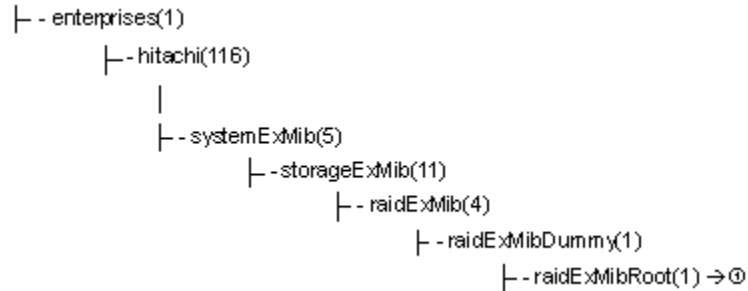

Figure 3-4 Extension MIB configuration (1)

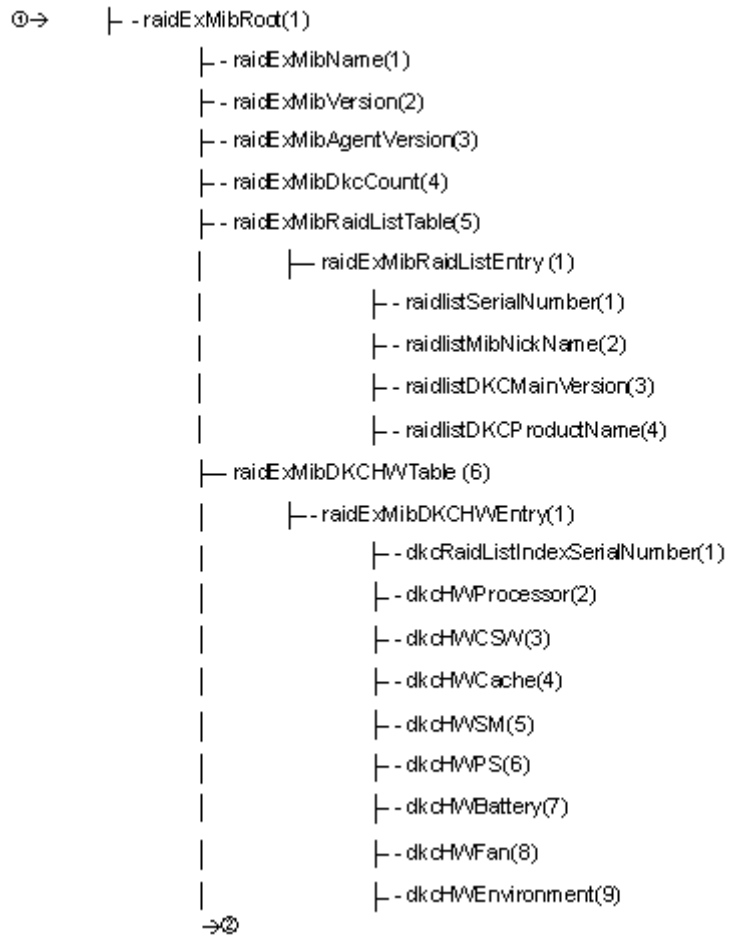

Figure 3-5 Extension MIB configuration (2)

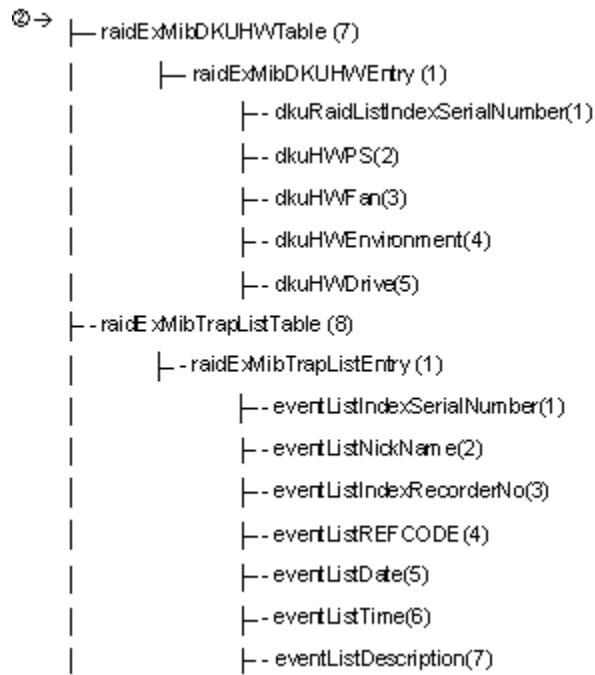

Figure 3-6 Extension MIB configuration (3)

SNMP failure trap reference

This topic shows the alert level, trap reference code, description, and alert level.

- [SNMP failure trap reference codes](#)

SNMP failure trap reference codes

The following lists and describes the SNMP failure trap reference codes.

Table 4-1 SNMP failure trap reference codes

Trap reference code			Description	Alert level
SIM 22	SIM 23	SIM 13		
14	00	x0	Ethernet error for SVP	DKC environment MODERATE
14	01	x0	Failure during SIM transfer to the SVP	DKC environment SERIOUS
18	00	00	Audit log disappeared	DKC environment MODERATE
18	01	00	System Disk not access	Drive failure MODERATE
21	20	xx	Channel port block	Processor MODERATE
21	30	xx	CHB Blocking	Processor MODERATE
21	40	xx	DKB Blocking	Processor MODERATE
21	80	xy	Logical paths on the remote copy connections was logically blocked (Due to an error conditions)	Processor MODERATE
21	81	xy	The logical path has been recovered from blocked condition on the remote copy conditions	Processor SERVICE
21	93	xy	Link data transfer error	Processor SERIOUS
21	94	xy	Link data transfer error	Processor SERIOUS
21	D0	xy	External storage system connection path blocking	Processor MODERATE
21	D2	xy	Threshold over by external storage system connection path response time-out	Processor SERVICE
30	73	xy	Processor blockade	Processor MODERATE
30	75	xy	FM failure	Processor MODERATE
30	A1	00	DKC blockade	Processor Acute
39	A0	00	The upper temperature limit was exceeded	DKC environment SERVICE
43	Bx	xx	Drive blockade (Media system) xxx: The drive number	Drive failure SERIOUS
43	Cy	xx	Drive blockade (Media system)	Drive SERIOUS
45	1y	xx	Correction copy start	Drive SERVICE
45	2y	xx	Correction copy normal end	Drive SERVICE
45	3y	xx	Correction copy abnormal end	Drive SERIOUS
45	5y	xx	Correction copy warning end	Drive SERVICE
46	1y	xx	Dynamic sparing start	Drive SERVICE
46	2y	xx	Dynamic sparing normal end	Drive SERVICE

Trap reference code			Description	Alert level	
SIM 22	SIM 23	SIM 13			
46	3y	xx	Dynamic sparing abnormal end	Drive	MODERATE
46	5y	xx	Dynamic sparing warning end	Drive	SERVICE
47	Dx	xx	SI Copy abnormal end	Failure with paired volumes	MODERATE
47	E7	00	Forcible suspend by SM volatile (SI)	Failure with paired volumes	MODERATE
50	Bx	yy	Flash drive end of life	Drive	SERVICE
50	Cx	xx	Flash module drive end of life	Drive	SERVICE
62	0x	xx	The DP Pool Warning Threshold was exceeded	Dynamic Provisioning Pool	MODERATE
62	2x	xx	DP Pool FULL	Dynamic Provisioning Pool	MODERATE
62	3x	xx	DP Pool error is detected	Dynamic Provisioning Pool	MODERATE
62	40	00	No free area in SM	Dynamic Provisioning Pool	MODERATE
62	50	00	DP Pool threshold continues to be exceeded	Dynamic Provisioning Pool	MODERATE
62	6x	xx	The DP Pool Depletion threshold was exceeded	Dynamic Provisioning Pool	MODERATE
62	7x	xx	The DP Pool VOL blockade	Dynamic Provisioning Pool	MODERATE
62	80	00	DP Protect attribute setting of DRU	Dynamic Provisioning Pool	SERVICE
66	10	00	Acquisition failure of the outside encryption key	Encryption key	MODERATE
67	00	00	Warning for depletion of cache management devices	Thin Image	MODERATE
7B	00	03	ISDN Router failure	SVP failure	MODERATE
7C	03	00	Audit log FTP transfer failed	SVP failure	MODERATE
7C	04	00	Dump Tool failed	SVP failure	SERVICE
7E	12	xx	MP OPERATING RATIO ERROR	Processor	MODERATE
7F	F4	xx	Clean virus from file	SVP failure	SERVICE
7F	F5	xx	Virus detected (Virus isolated)	SVP failure	MODERATE

Trap reference code			Description	Alert level	
SIM 22	SIM 23	SIM 13			
7F	F6	xx	Virus detected (Virus isolation failed)	SVP failure	SERIOUS
7F	F7	xx	Expiration	License key	SERIOUS
7F	F8	xx	Exceeded the licensed capacity	License key	SERIOUS
7F	F9	xx	Program product invalidated by the expiration of the prerequisite program product	License key	SERIOUS
7F	FA	00	Failure of adjusting the clock	Adjusting the clock	SERVICE
AC	50	xy	HDU power supply shutdown detected	PS (DB)	MODERATE
BF	1x	1x	Abnormal temperature	DKC environment	MODERATE
BF	4x	1x	Warning for power supply	PS (DKC)	MODERATE
BF	5x	xx	DBPS error	PS (DB)	MODERATE
BF	6x	xx	DBPS AC input error	PS (DB)	MODERATE
BF	7x	xx	Warning for fan	Fan (DKC)	MODERATE
BF	85	A3	SVP RAS Switch#1 remains (SVP PS ON/OFF INH SW)	SVP failure	MODERATE
BF	D1	xx	Battery charge EMPTY	Battery	MODERATE
BF	D4	xx	CM Backup mounting warning	Cache	MODERATE
CF	10	xx	SAS controller blockade	Processor	MODERATE
CF	12	xx	SAS port blockade	Processor	MODERATE
CF	6x	xx	Logical DMA blocking	Processor	MODERATE
CF	82	xy	DRR blockade	Processor	MODERATE
CF	83	xy	DMA blockade	Processor	MODERATE
CF	88	xx	MAIN Blade blocking	Processor	MODERATE
CF	89	xx	All DMA blockade	Processor	MODERATE
D0	0x	xx	TC/HAM started the initial copy or out of sync for this volume	Failure with paired volumes	SERVICE
D0	1x	xx	TC/HAM completed the initial copy for this volume	Failure with paired volumes	SERVICE
D0	2x	xx	TC/HAM for this volume was deleted (Operation from an SVP/Web Console or a host processor)	Failure with paired volumes	SERVICE
D0	6x	xx	Completed the Create pair (No copy suspend)	Failure with paired volumes	SERVICE
D1	0x	xx	Status of the R-VOL is changed. (*)From Simplex to Duplex Pending	Failure with paired volumes	SERVICE

Trap reference code			Description	Alert level	
SIM 22	SIM 23	SIM 13			
D1	1x	xx	Status of the R-VOL is changed. (*From Simplex to Duplex	Failure with paired volumes	SERVICE
D1	2x	xx	Status of the R-VOL is changed. (*From Duplex Pending to Duplex	Failure with paired volumes	SERVICE
D1	3x	xx	Status of the R-VOL is changed. (*From Duplex Pending to Suspend	Failure with paired volumes	SERVICE
D1	4x	xx	Status of the R-VOL is changed. (*From Duplex to Suspend	Failure with paired volumes	SERVICE
D1	5x	xx	Status of the R-VOL is changed. (*From Duplex to Simplex	Failure with paired volumes	SERVICE
D1	6x	xx	Status of the R-VOL is changed. (*From Duplex Pending to Simplex	Failure with paired volumes	SERVICE
D1	7x	xx	Status of the R-VOL is changed. (*From Suspend to Simplex	Failure with paired volumes	SERVICE
D1	8x	xx	Status of the R-VOL is changed. (*From Suspend to Duplex Pending	Failure with paired volumes	SERVICE
D1	9x	xx	Status of the R-VOL is changed. (*From Duplex Pending to Suspend (continue)	Failure with paired volumes	SERVICE
D1	Ax	xx	Status of the R-VOL is changed. (*From Duplex Pending to Suspend (complete)	Failure with paired volumes	SERVICE
D1	Bx	xx	Status of the R-VOL is changed. (*From Suspend (continue) to Suspend	Failure with paired volumes	SERVICE
D1	Cx	xx	Status of the R-VOL is changed. (*From Simplex to Suspend	Failure with paired volumes	SERVICE
D4	0x	xx	TC/HAM for this volume was suspended (Due to an unrecoverable failure on the remote copy connections)	Failure with paired volumes	SERIOUS
D4	1x	xx	TC/HAM for this volume was suspended (Due to an unrecoverable failure on the remote copy connections)	Failure with paired volumes	SERIOUS
D4	2x	xx	TC/HAM for this volume was suspended (Due to an unrecoverable failure on the R-VOL)	Failure with paired volumes	SERIOUS

Trap reference code			Description	Alert level	
SIM 22	SIM 23	SIM 13			
D4	3x	xx	This volume was suspended (Caused by DFW to the R-VOL was prohibited)	Failure with paired volumes	SERIOUS
D4	4x	xx	TC/HAM for this volume was suspended (Due to an internal error condition detected by the RCU)	Failure with paired volumes	SERIOUS
D4	5x	xx	TC/HAM for this volume was suspended (Caused by Delete pair operation was issued to the R-VOL)	Failure with paired volumes	SERIOUS
D4	Fx	xx	Status of the M-VOL was not consistent with the R-VOL	Failure with paired volumes	SERIOUS
D8	0x	xx	A volume to be used by the UR was defined	Failure with paired volumes	SERVICE
D8	1x	xx	The volume being used by the UR began a copying	Failure with paired volumes	SERVICE
D8	2x	xx	The volume being used by the UR completed a copying	Failure with paired volumes	SERVICE
D8	3x	xx	The volume being used by the UR received a request for suspension	Failure with paired volumes	SERVICE
D8	4x	xx	The volume being used by the UR completed a suspension transaction	Failure with paired volumes	SERVICE
D8	5x	xx	The volume being used by the UR received a request for deletion	Failure with paired volumes	SERVICE
D8	6x	xx	The volume being used by the UR completed the deletion	Failure with paired volumes	SERVICE
D8	7x	xx	The volume being used by the UR was defined (placed in the PSUS status immediately)	Failure with paired volumes	SERVICE
D8	8x	xx	A Delta volume to be used by the UR was defined	Failure with paired volumes	SERVICE
D8	9x	xx	A Delta volume to be used by the UR was redefine	Failure with paired volumes	SERVICE
D9	0x	xx	A change to an S-VOL was received from the MCU. (*)From Simplex to Duplex Pending	Failure with paired volumes	SERVICE

Trap reference code			Description	Alert level
SIM 22	SIM 23	SIM 13		
D9	1x	xx	A change to an S-VOL was received from the MCU. (*)From Simplex to Duplex	Failure with paired volumes SERVICE
D9	2x	xx	A change to an S-VOL was received from the MCU. (*)From Duplex Pending to Duplex	Failure with paired volumes SERVICE
D9	3x	xx	A change to an S-VOL was received from the MCU. (*)From Duplex Pending to Suspend	Failure with paired volumes SERVICE
D9	4x	xx	A change to an S-VOL was received from the MCU. (*)From Duplex to Suspend	Failure with paired volumes SERVICE
D9	5x	xx	A change to an S-VOL was received from the MCU. (*)From Duplex to Simplex	Failure with paired volumes SERVICE
D9	6x	xx	A change to an S-VOL was received from the MCU. (*)From Duplex Pending to Simplex	Failure with paired volumes SERVICE
D9	7x	xx	A change to an S-VOL was received from the MCU. (*)From Suspend to Simplex	Failure with paired volumes SERVICE
D9	8x	xx	A change to an S-VOL was received from the MCU. (*)From Suspend to Duplex Pending	Failure with paired volumes SERVICE
D9	9x	xx	A change to an S-VOL was received from the MCU. (*)From Hold to Duplex	Failure with paired volumes SERVICE
D9	Ax	xx	A change to an S-VOL was received from the MCU. (*)From Hold to Duplex Pending	Failure with paired volumes SERVICE
D9	Cx	xx	A change to an S-VOL was received from the MCU. (*)From Simplex to Suspend	Failure with paired volumes SERVICE
D9	Dx	xx	A change to an S-VOL was received from the MCU. (*)From Simplex to Hold	Failure with paired volumes SERVICE
D9	Ex	xx	A change to an S-VOL was received from the MCU. (*)From Suspend to Hold	Failure with paired volumes SERVICE
D9	Fx	xx	A change to an S-VOL was received from the MCU. (*)From Duplex to Duplex Pending	Failure with paired volumes SERVICE
DC	0x	xx	Volume used as P-VOL has been suspended (Unable to restore path)	Failure with paired volumes SERIOUS

Trap reference code			Description	Alert level	
SIM 22	SIM 23	SIM 13			
DC	1x	xx	Volume used as P-VOL has been suspended (MCU failure detected)	Failure with paired volumes	SERIOUS
DC	2x	xx	A volume being used by a P-VOL was suspended (Suspension of an S-VOL failure was detected)	Failure with paired volumes	SERIOUS
DC	4x	xx	Volume used as P-VOL has been suspended (S-VOL suspension detected)	Failure with paired volumes	SERIOUS
DC	5x	xx	Volume used as P-VOL has been suspended (S-VOL pair deletion detected)	Failure with paired volumes	SERIOUS
DC	6x	xx	Volume used as S-VOL has been suspended (Unable to restore path)	Failure with paired volumes	SERIOUS
DC	7x	xx	Volume used as S-VOL has been suspended (RCU failure detected)	Failure with paired volumes	SERIOUS
DC	9x	yy	Volume used as a P-VOL of Delta resync has been suspended x: The CU number yy: The LDEV number	Failure with paired volumes	SERIOUS
DC	Ax	yy	Pair suspend (Spread by error of another Affiliate)	Failure with paired volumes	SERIOUS
DF	8y	xx	Drive port blockade (Path 0 side)	Drive	MODERATE
DF	9y	xx	Drive port blockade (Path 1 side)	Drive	MODERATE
DF	Ay	xx	LDEV blockade (Drive path: Boundary 0/ Effect of Drive port blockade)	Drive	SERIOUS
DF	By	xx	LDEV blockade (Drive path: Boundary 1/ Effect of Drive port blockade)	Drive	SERIOUS
EF	0x	xx	Drive blockade (drive) (with redundancy)	Drive failure	SERIOUS
EF	1y	xx	Drive blockade (drive) (without redundancy)	Drive	SERIOUS
EF	2x	xx	Drive blockade (Effect of Dynamic sparing normal end)	Drive	SERVICE
EF	9y	xx	LDEV blockade (Effect of drive blockade)	Drive	SERIOUS
EF	D0	00	Device connecting to external storage system is blocked	Drive	SERIOUS
EF	FE	xx	UNIT connection cable order error	Processor	MODERATE

Trap reference code			Description	Alert level	
SIM 22	SIM 23	SIM 13			
FF	C2	xy	Cache Module Blockade processing finished	Cache	SERVICE
FF	C3	0x	REAL MEMORY SIZE INCONSISTENT	Cache	SERVICE
FF	E2	0x	Area blocking	SM	SERIOUS
FF	E7	xx	Rebooted with volatilization after an instantaneous down	SM	SERIOUS
FF	EA	0x	Recovery of area blocked temporarily was completed	SM	SERVICE
FF	EE	0x	Temporary blockade	SM	SERVICE
FF	F1	xy	Cache temporary failure	Cache	SERVICE
FF	F2	xy	Module group blocking	Cache	MODERATE
FF	F3	0x	Package blockade	Cache	MODERATE
FF	F4	0x	Module group blocking	Cache	SERIOUS
Others			Other failures	Other failures	SERIOUS

Troubleshooting

This topic provides troubleshooting information for the Hitachi SNMP Agent.

- [Getting help](#)
- [Solving SNMP problems](#)

Getting help

If you have difficulty with any of the procedures included in this topic, or if a procedure does not provide the answer or results you expect, please contact Hitachi Data Systems Support Center. See [Getting help on page Preface-viii](#) in the Preface for information about accessing the support portal.

Solving SNMP problems

Use setup.exe when you install a secondary SVP. If you do not, traps could be reported to an IP address that is not specified in SNMP settings. This could have serious consequences, including the following:

- **SNMP security function**

If the SNMP security function is working, and a command is executed from an IP address that is not entered, you will get a “no reply” return and a certification error is received for a trap.

- **SNMP cold trap function**

- Depending on your network environment, when the SVP is rebooted you might not receive Microsoft agent SNMP Agent cold traps.
- The Microsoft SNMP Agent might report Link up/Link down Trap when the SVP reboots.
- A number of Link up/Link down Traps may be reported when the OS of the SVP is Windows Vista.

- **Abnormal response to SNMP command**

If an error occurs in the SVP, traps might not be sent.

- **Problems inputting MIB definition files**

If you cannot input two or more MIB definition files because of the specifications of the SNMP manager software, use the MIB definition files for HUS VM. Error reports include storage system nicknames, which can be used to identify each storage system.



SNMP GUI reference

This appendix describes the procedures to use the SNMP Information window.

- [SNMP Information window](#)

SNMP Information window

1. Launch Storage Navigator and log in.
2. In the Storage Navigator main window, click **Settings** > **Environmental Setting** > **SNMP Information** in the menu bar. The SNMP Information window is displayed.

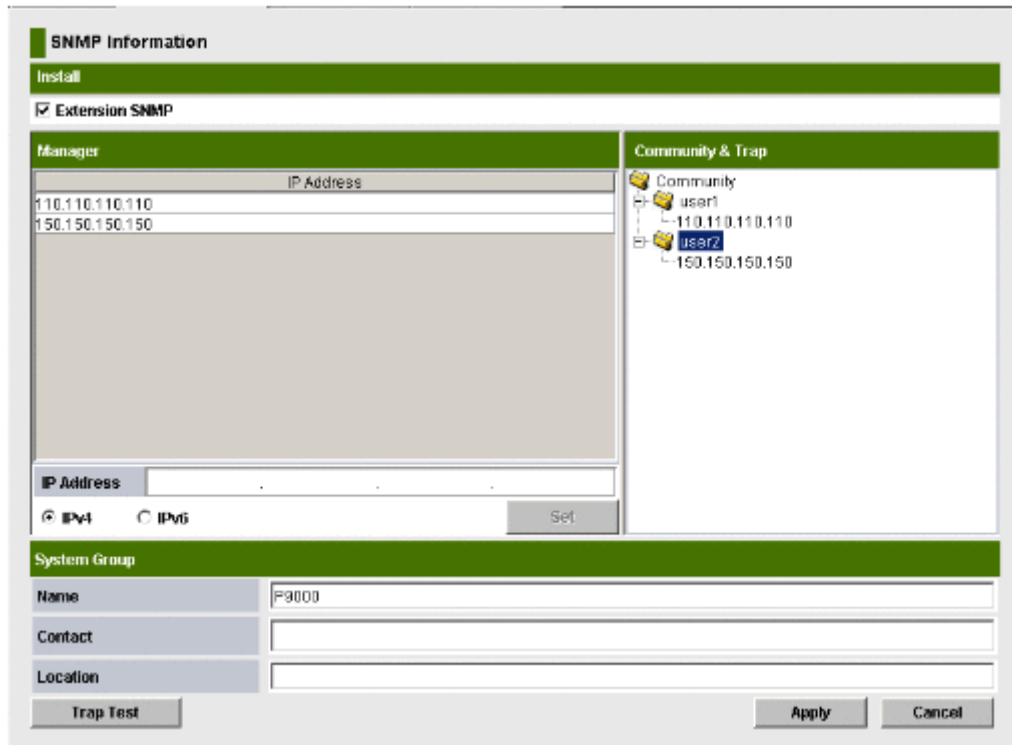

3. In the SNMP Information window, click **SNMP Information**. The following table describes the items that are displayed.

Table A-1 SNMP Information window

Item	Description
Install	The Extension SNMP check-box is selected if the SNMP Agent feature is enabled. To set the SNMP Agent properties from the Storage Navigator console, select Extension SNMP in the SNMP Information window.
Manager	The Manager section allows you to add and delete SNMP Manager information.
IP Address	Displays the IP addresses of registered SNMP managers from which the SNMP Agent accepts requests. If no manager is registered, the SNMP Agent accepts requests from all managers. You can register up to 32 managers.

Item	Description
IP Address	<p>Enter the IP address of the manager that the SNMP Agent receives the request from.</p> <ul style="list-style-type: none"> • IPv4 and IPv6 addresses can be specified for IP Address. However, if the OS of the SVP is Windows XP and you enter the IPv6 address and select Apply, an error message is displayed and the IPv6 address is not set. • Any IP address having all values set to zero (0) cannot be specified for IPv4 and IPv6. • The IPv4 address is specified by entering four numbers that are separated by periods (.) using a maximum of three digits from zero (0) to 255 inclusive. (For example: XXX.XXX.XXX.XXX when X is a number). Enter the numbers only and do not enter periods. • The IPv6 address is specified by entering eight hexadecimal numbers that are separated by colons (:) using a maximum of 4 digits from zero (0) to FFFF inclusive. (For example: YYYY:YYYY:YYYY:YYYY:YYYY:YYYY:YYYY:YYYY when Y is a hexadecimal number). Enter the hexadecimal numbers only, and do not enter the colons. The cursor can be moved between the entry fields using the Tab key.
IPv4	Is selected when entering an <i>IPv4</i> address. The IPv4 address can be entered in the IP address text box when this button is selected.
IPv6	Is selected when entering an <i>IPv6</i> address. The IPv6 address can be entered in the IP address text box when this button is selected.
Set	Adds new IP addresses to the <i>IP Address</i> list box.
Community & Trap	<p>Allows you to add, delete, or change SNMP trap information. The registered IP address is the trap destination for the specified community.</p> <ul style="list-style-type: none"> • Each community can have more than one defined IP address (see Adding a community name on page 2-4 and Adding a community IP address on page 2-7). • You can register up to 32 community names and up to 32 IP addresses per community name. • You can use up to 180 alphanumeric characters in a community name. You cannot use the following special characters: ", \, ;, : , , * , ? , < , > , , / , ^ , & , and %.

Item	Description
System Group	<p>Allows you to add, delete or change SNMP system group information. If system group information has already been registered, the registered information displays. To register the system group information, the Extension SNMP check-box must be selected. To register system group information, click Apply. System group information includes the following items:</p> <ul style="list-style-type: none"> • Name: This is the name of the connected storage system device. Storage Navigator users can change the device name. The name can include up to 180 alphanumeric characters, but cannot include the following special characters: ", \, ;, :, , , *, ?, <, >, , /, ^, &, and %. <p>The device name is required to use SNMP Agent. Make sure to document the device name, because settings will be cleared when the SVP is replaced.</p> <ul style="list-style-type: none"> • Contact: Contact information such as personnel and telephone numbers where you can inquire about the connected storage system. Storage Navigator users can change contact information in the Modify mode. contact information using up to 180 alphanumeric characters (ASCII codes), except for some symbols, such as ", \, ;, :, , , *, ?, <, >, , /, ^, &, and %. <p>A contact name is required to use SNMP Agent. Make sure to document the contact name, because settings will be cleared when the SVP is replaced.</p> <ul style="list-style-type: none"> • Location: Location of connected storage system. Storage Navigator users can change device locations with the modify mode. You must enter a device location using up to 180 alphanumeric characters (ASCII codes). You cannot use some symbols, such as ", \, ;, :, , , *, ?, <, >, , /, ^, &, and %. <p>The device location is required to use SNMP Agent. Make sure to document the device location, because the settings will be cleared when SVP is replaced.</p>
Trap Test	Executes test report of the trap to the community registered in the Unified Storage VM storage system. You must be in Modify mode to use this button. You must have Storage Administrator privileges.
Apply	Implements settings made on this window. You must be in Modify mode to use this button. You must have Storage Administrator privileges.
Cancel	Cancels settings made on this window.



Glossary

This glossary defines the special terms used in this document. Click the letter links below to navigate.

C

Community Name

An SNMP entity in which up to 32 names and up to 32 IP addresses can be registered.

E

Extension Trap

An error message generated by a third-party node and sent to the SNMP agent.

F

Failure Trap

An error message that indicates a problem within a managed node.

I

IPv4

Internet Protocol version 4

IPv6

Internet Protocol version 6

#	A	B	C	D	E	F	G	H	I	J	K	L	M	N	O	P	Q	R	S	T	U	V	W	X	Y	Z
---	-------------------	-------------------	-------------------	-------------------	-------------------	-------------------	-------------------	-------------------	-------------------	-------------------	-------------------	-------------------	-------------------	-------------------	-------------------	-------------------	-------------------	-------------------	-------------------	-------------------	-------------------	-------------------	-------------------	-------------------	-------------------	-------------------

M

Managed Device

A network node on which the SNMP agent software is installed. Using the agent, managed devices exchange node-specific information with the SNMP management software.

MIB

Management Information Base - a standardized configuration and database of network management information. It is common to all SNMP interfaces

P

PDU

power distribution unit; protocol data unit

S

SGMP

simple gateway management protocol

SNMP

Simple Network Management Protocol - an industry-standard protocol that is used to manage and monitor network-attached devices for conditions that warrant administrative attention. The devices can include disk devices, routers, and hubs. SNMP uses Simple Gateway Management Protocol (SGMP) to manage TCP/IP gateways.

SNMP Agent

Software that is installed on the SVP and responds to queries from the SNMP manager.

SNMP Manager

Software that It is installed on the computer where Storage Navigator is installed.

SNMP Trap

An error message generated by a node and sent to the SNMP agent. The SNMP agent passes the message to the SNMP manager.

#	A	B	C	D	E	F	G	H	I	J	K	L	M	N	O	P	Q	R	S	T	U	V	W	X	Y	Z
---	---	---	-------------------	---	-------------------	-------------------	---	---	-------------------	---	---	---	-------------------	---	---	-------------------	---	---	-------------------	---	-------------------	---	---	---	---	---

Glossary-2

U

UDP

user datagram protocol - software that requests data regarding the status of a managed node.

#	A	B	C	D	E	F	G	H	I	J	K	L	M	N	O	P	Q	R	S	T	U	V	W	X	Y	Z
---	---	---	-------------------	---	-------------------	-------------------	---	---	-------------------	---	---	---	-------------------	---	---	-------------------	---	---	-------------------	---	-------------------	---	---	---	---	---

#	A	B	C	D	E	F	G	H	I	J	K	L	M	N	O	P	Q	R	S	T	U	V	W	X	Y	Z
---	---	---	-------------------	---	-------------------	-------------------	---	---	-------------------	---	---	---	-------------------	---	---	-------------------	---	---	-------------------	---	-------------------	---	---	---	---	---

Glossary-4

Index

A

adding
 community names 2-4, 2-7
 SNMP Manager IP addresses 2-2
architecture, SNMP environment 1-3

C

changing community names 2-6
cold trap function, troubleshooting 5-2
community names
 adding 2-4, 2-7
 changing 2-6
 deleting 2-5
components, storage system 1-6
configuration, SNMP Agent 1-3

D

definition files, trouble inputting 5-2
deleting
 community names 2-5
 SNMP Manager IP addresses 2-3

E

environment architecture, SNMP 1-3
errors
 REQUEST operation 1-5
 SNMP Agent 1-5
extension configuration, MIB 3-10
extension trap
 protocol data unit (PDU) 3-2
 types 3-2

F

failure
 report 3-2
 trap reference codes 4-2
functions, SNMP Agent 1-4

H

help 5-2

I

interaction, SNMP Manger and SNMP Agent 1-2

M

Management Information Base (MIB) 1-3
MIB
 access mode 3-3
 extension configuration 3-10
 extension specifications 3-5
 mounting specifications 3-4
 object identifier system 3-3
 specifications 3-3
 supported 3-3
MIB definition files, trouble inputting 5-2
mounting
 MIB specifications 3-4
 system groups 3-4

O

operations, SNMP Agent 1-5
overview 1-2

P

protocol data unit (PDU) 3-2

R

raidExMibAgentVersion 3-5
raidExMibDkcCount 3-6
raidExMibDKCHW 3-7
raidExMibDKUHW 3-8
raidExMibName 3-5
raidExMibRaidList 3-6
raidExMibTrapList 3-9
raidExMibVersion 3-5

S

security function, troubleshooting 5-2
Simple Network Management Protocol
(SNMP) 1-2
SNMP Agent

- configuration 1-3
- errors 1-5
- functions 1-4
- operations 1-5
- traps 1-4
- SNMP environment architecture 1-3
- SNMP failure, trap reference codes 4-2
- SNMP Manager
 - component status 1-6
 - overview 1-2
- SNMP Manager IP addresses
 - adding 2-2
 - deleting 2-3
- specifications
 - MIB mounting 3-4
- status, storage system components 1-6
- system groups, mounting 3-4

T

- traps
 - failure reference codes 4-2
 - failure report 3-2
 - SNMP Agent 1-4
 - supported types 3-2
 - triggers 1-4
- troubleshooting
 - abnormal response to SNMP commands 5-2
 - inputting MIB definition files 5-2
 - SNMP cold trap function 5-2
 - SNMP security function 5-2

Hitachi Data Systems

Corporate Headquarters

2845 Lafayette Street
Santa Clara, California 95050-2639
U.S.A.

www.hds.com

Regional Contact Information

Americas

+1 408 970 1000

info@hds.com

Europe, Middle East, and Africa

+44 (0)1753 618000

info.emea@hds.com

Asia Pacific

+852 3189 7900

hds.marketing.apac@hds.com



MK-92HM7014-03