

# Hitachi Command Suite Software Mainframe Agent Installation and Configuration Guide

## FASTFIND LINKS

- Document Organization
- Product Version
- Getting Help
- Contents

Copyright ©2010 Hitachi Ltd., Hitachi Data Systems Corporation, ALL RIGHTS RESERVED

Notice: No part of this publication may be reproduced or transmitted in any form or by any means, electronic or mechanical, including photocopying and recording, or stored in a database or retrieval system for any purpose without the express written permission of Hitachi Ltd., and Hitachi Data Systems Corporation (hereinafter referred to as "Hitachi Data Systems").

Hitachi Ltd. and Hitachi Data Systems reserve the right to make changes to this document at any time without notice and assume no responsibility for its use. Hitachi Ltd. and Hitachi Data Systems products and services can only be ordered under the terms and conditions of Hitachi Data Systems' applicable agreements. All of the features described in this document may not be currently available. Refer to the most recent product announcement or contact your local Hitachi Data Systems sales office for information on feature and product availability.

This document contains the most current information available at the time of publication. When new and/or revised information becomes available, this entire document will be updated and distributed to all registered users.

Hitachi is a registered trademark of Hitachi, Ltd. in the United States and other countries. Hitachi Data Systems is a registered trademark and service mark of Hitachi, Ltd. in the United States and other countries.

Lightning 9900, Hitachi USP and Hitachi USP V are trademarks of Hitachi Data Systems Corporation in the United States and other countries.

MVS, OS/390, RACF, z/OS, zSeries are trademarks of International Business Machines Corporation in the United States, other countries, or both.

All other brand or product names are or may be trademarks or service marks of and are used to identify products or services of their respective owners.



# Contents

Preface.....	vii
Intended Audience.....	viii
Product Version.....	viii
Release Notes.....	viii
Document Revision Level.....	viii
Document Organization.....	viii
Referenced Documents.....	ix
Document Conventions.....	x
Convention for Storage Capacity Values.....	xi
Getting Help.....	xi
Comments.....	xii
<b>1. About Mainframe Agent.....</b>	<b>1-1</b>
Why Use Mainframe Agent?.....	1-2
Installation Requirements.....	1-2
Operating System Requirements.....	1-2
Application Software Requirements.....	1-2
Prerequisite Equipment.....	1-3
System Configuration Example.....	1-3
Using Device Manager to View Storage Information.....	1-4
Using Replication Manager to Monitor PPRC Copy Pairs.....	1-5
Using Device Manager to View Storage Information and Replication Manager to Monitor PPRC Copy Pairs .....	1-5
<b>2. Installing Mainframe Agent.....</b>	<b>2-1</b>
Installation Overview.....	2-2
Pre-installation Checks.....	2-2
Provided Datasets.....	2-2
Storage Attributes of Library Datasets.....	2-3
Memory Requirements.....	2-4
For linkage with Device Manager:.....	2-4
For linkage with Replication Manager:.....	2-4
Installation Procedure.....	2-4
Installing Mainframe Agent.....	2-4
Installing the REXX Alternate Libraries.....	2-6

Settings for Using the YKALCSVC Command.....	2-6
Registering a User SVC.....	2-7
Using the IEASVCxx Parmlib Member to Register.....	2-8
Using the YKALCSVC Command to Register.....	2-8
Settings for Using the YKP2A Command.....	2-9
Upgrading Mainframe Agent.....	2-9
Notes for Upgrading.....	2-9
Checks Before Upgrading.....	2-10
Checking Whether to Upgrade Device Manager.....	2-10
Checking the User SVC Number.....	2-10
Backing Up Datasets.....	2-10
Pre-Upgrade Procedure.....	2-10
Deleting the User SVC .....	2-10
Removing the Concatenation of Cataloged Procedure Libraries.....	2-11
Removing the Concatenation of Load Libraries.....	2-11
Upgrading Mainframe Agent.....	2-11
Checking Settings After Upgrading.....	2-11

<b>3. Setting Up Mainframe Agent.....</b>	<b>3-1</b>
Setting the TCP/IP Port Number.....	3-2
Setting the Security.....	3-2
Setting the Dataset Security.....	3-2
Setting Up the Resource Access Control Facility (RACF).....	3-3
Setting Up IBM HTTP Server.....	3-4
Settings for Connecting via IPv6.....	3-4
Collecting the Trace Log.....	3-5
Creating Initialization Parameters.....	3-5
How to Use the SETINIT Command.....	3-6
Continuing to the Next Line.....	3-7
Entering Comments.....	3-8
Notes During Creation of Initialization Parameters.....	3-8
Details of Initialization Parameters.....	3-8
Format.....	3-8
Parameters.....	3-8
Multiple Specifications of Initialization Parameters.....	3-11
Examples of Specifying Initialization Parameters.....	3-12
When Connecting to Device Manager.....	3-12
When Connecting to Replication Manager.....	3-14
Examples of Initialization Parameter Analysis Results.....	3-15
Creating a Cataloged Procedure for Startup.....	3-16
Standard Cataloged Procedure for Startup.....	3-16
Standard Cataloged Procedure for Startup in the Expanded Format.....	3-16
Description.....	3-16
Notes.....	3-17
Changing the Cataloged Procedure for Startup.....	3-18
Setting Up the Device Manager Environment.....	3-18
Displaying Mainframe Storage Information.....	3-18
Registering the Mainframe Host in Device Manager.....	3-18
Registering the Mainframe Agent Running on the Mainframe Host.....	3-19
Acquiring Mainframe Storage Information.....	3-20
Refreshing Mainframe Storage Information.....	3-21
Acquiring Mainframe Agent Information Registered in the Device Manager.....	3-22

Changing Mainframe Agent Information Registered in the Device Manager.....	3-22
Deleting Mainframe Agent Information Registered in the Device Manager.....	3-22
Acquiring Mainframe Host Information.....	3-23
Changing Mainframe Host Information.....	3-23
Deleting a Mainframe Host.....	3-24
Setting Up the Replication Manager Environment.....	3-24
Registering an Information Source.....	3-24
Setting the Interval for Collecting Configuration Information.....	3-24
Setting the Interval for Collecting Copy Pair Status Information.....	3-24
<b>4. Using Mainframe Agent.....</b>	<b>4-1</b>
Using Device Manager to Collect Mainframe System Storage Information.....	4-2
Operation Overview.....	4-2
Operating Procedure During Installation.....	4-2
Operating Procedure for Changing a Configuration.....	4-3
Using Replication Manager to Monitor PPRC Copy Pairs.....	4-4
Operation Overview.....	4-4
Operation Procedures.....	4-5
Prerequisites for the Copy Group Definition Generation Function.....	4-7
Prerequisite Hardware.....	4-7
Software Settings.....	4-7
Copy Types and Units That Can Generate Configuration Files.....	4-8
Supported PPRC Commands.....	4-8
YKP2A Command.....	4-10
Format.....	4-10
Function.....	4-10
Parameter.....	4-11
Notes.....	4-13
Return codes.....	4-13
Examples of Generating Configuration Files.....	4-14
Example Configuration for Monitoring PPRC TrueCopy and TrueCopy	
Asynchronous Copy Pairs.....	4-14
Example Configuration for Monitoring Only PPRC ShadowImage Copy Pairs	4-16
Example Configuration for Monitoring PPRC TrueCopy and ShadowImage Copy	
Pairs.....	4-17
Operation Commands.....	4-18
Starting a Mainframe Agent.....	4-18
Format.....	4-18
Operands.....	4-18
Example.....	4-19
Stopping a Mainframe Agent.....	4-19
Format.....	4-19
Operands.....	4-19
Example.....	4-19
Return Codes.....	4-20
Forcibly Stopping a Mainframe Agent.....	4-20
Format.....	4-20
Operands.....	4-20
Example.....	4-21
Displaying the Log Output Level.....	4-21
Format.....	4-21
Operands.....	4-21

Example.....	4-21
Changing the Log Output Level.....	4-22
Format.....	4-22
Operands.....	4-22
Example.....	4-22
<b>5. Messages.....</b>	<b>5-1</b>
Message Format.....	5-2
Message Output Format.....	5-2
Notations Used to Describe Messages.....	5-2
Message Output Destination.....	5-3
List of Messages.....	5-3
User Completion Codes.....	5-27
<b>6. Troubleshooting.....</b>	<b>6-1</b>
Information Output to Logs.....	6-2
When Mainframe Agent Cannot Be Started.....	6-4
When a Mainframe Agent Cannot Be Started.....	6-4
When Information from Mainframe Agent Is Not Updated.....	6-5
When Information Obtained from a Mainframe Agent Is Not Updated.....	6-5
<b>A Command Format.....</b>	<b>A-1</b>
Symbols Used in Command Explanations.....	A-2
Syntax Elements for Commands.....	A-2

Acronyms and abbreviations

Glossary

Index



# Preface

This document describes how to use the program product Hitachi Device Manager Mainframe Agent:

Hereafter, this product is abbreviated to *Mainframe Agent*.

- Intended Audience
- Product Version
- Release Notes
- Document Revision Level
- Document Organization
- Referenced Documents
- Document Conventions
- Convention for Storage Capacity Values
- Getting Help
- Comments

## Intended Audience

This manual is intended for system administrators who install, set up, operate, or troubleshoot the Mainframe Agent.

The readers of this manual should have a basic knowledge of the:

- communication servers
- operating system on which Mainframe Agent is installed (OS/390 or z/OS)
- Device Manager
- For linkage with Replication Manager, knowledge of Replication Manager

## Product Version

This document revision applies to Hitachi Device Manager Mainframe Agent version 7.0 and higher.

## Release Notes

Release notes can be found on the documentation CD. Release notes contain requirements and more recent product information that may not be fully described in this manual. Be sure to review the release notes before installation.

## Document Revision Level

Revision	Date	Description
MK-96HC13 0-00	June 2006	Initial Release
MK-96HC13 0-01	June 2007	Revision 1, supersedes and replaces MK-96HC130-00
MK-96HC13 0-02	May 2008	Revision 2, supersedes and replaces MK-96HC130-01
MK-96HC13 0-03	February 2009	Revision 3, supersedes and replaces MK-96HC130-02
MK-96HC13 0-04	December 2009	Revision 4, supersedes and replaces MK-96HC130-03
MK-96HC13 0-05	October 2010	Revision 5, supersedes and replaces MK-96HC130-04

## Document Organization

The following table provides an overview of the contents and organization of this document. Click the chapter title in the left column to go to that chapter. The first page of each chapter provides links to the sections in that chapter.



Chapter	Description
<a href="#">About Mainframe Agent on page 1-1</a>	Explains the purpose of Mainframe Agent.
<a href="#">Installing Mainframe Agent on page 2-1</a>	Provides an overview of installing Mainframe Agent, describes pre-installation checks, and explains the installation and upgrade procedures.
<a href="#">Setting Up Mainframe Agent on page 3-1</a>	Describes how to set up the environment to acquire storage information using Mainframe Agent.
<a href="#">Using Mainframe Agent on page 4-1</a>	Describes how to obtain storage information managed by a mainframe and monitor PPRC copy pairs from an open system.
<a href="#">Messages on page 5-1</a>	Describes the messages that are issued by Mainframe Agent.
<a href="#">Troubleshooting on page 6-1</a>	Describes the troubleshooting of Mainframe Agent.
<a href="#">A Command Format on page A-1</a>	Describes the symbols used in command explanations and syntax elements for commands.
<a href="#">Acronyms and abbreviations on page Acronyms-1</a>	Defines the acronyms and abbreviations used in this document.
<a href="#">Glossary on page Glossary-1</a>	Defines the special terms used in this document.
INDEX	Lists the topics in this document in alphabetical order.

## Referenced Documents

The following Hitachi referenced documents can be found on the applicable Hitachi documentation CD:

Hitachi Command Suite documents:

- *Hitachi Command Suite CLI Reference Guide* MK-90HC176
- *Hitachi Command Suite Replication Manager User Guide* MK-99HC166

Manuals related to OS/390:

- *Communications Server: IP User's Guide and Commands*, GC31-8514
- *Program Directory for IBM Library for REXX on zSeries Alternate Library*, GI10-3243
- *MVS Initialization and Tuning Reference*, SC28-1752
- *MVS System Codes*, GC28-1780
- *MVS System Commands*, GC28-1781
- *SecureWay Security Server RACF Security Administrator's Guide*, SC28-1915
- *TSO/E REXX Reference*, SC28-1975
- *eNetwork Communications Server: IP API Guide*, SC31-8516
- *Communications Server IP Configuration Guide*, SC31-8725
- *Communications Server IP Configuration Reference*, SC31-8726

Manuals related to z/OS:



- *Program Directory for IBM Library for REXX on zSeries Alternate Library*, GI10-3243
- *MVS Initialization and Tuning Reference*, SA22-7592
- *MVS System Codes*, SA22-7626
- *MVS System Commands*, SA22-7627
- *Security Server RACF Security Administrator's Guide*, SA22-7683
- *Security Server RACROUTE Macro Reference*, SA88-8621
- *TSO/E REXX Reference*, SA22-7790
- *Communications Server IP Configuration Guide*, SC31-8775
- *Communications Server IP Configuration Reference*, SC31-8776
- *Communications Server IP User's Guide & Commands*, SC31-8780
- *Communications Server IP API Guide*, SC31-8788



## Document Conventions

This document uses the following typographic conventions:

Convention	Description
<b>Bold</b>	Indicates text on a window, other than the window title, including menus, menu options, buttons, fields, and labels. Example: Click <b>OK</b> .
<i>Italic</i>	Indicates a variable, which is a placeholder for actual text provided by the user or system. Example: <i>copy source-file target-file</i> <i>Note:</i> Angled brackets (< >) are also used to indicate variables.
screen/code	Indicates text that is displayed on screen or entered by the user. Example: # pairdisplay -g oradb
< > angled brackets	Indicates a variable, which is a placeholder for actual text provided by the user or system. Example: # pairdisplay -g <group> <i>Note:</i> Italic font is also used to indicate variables.
[ ] square brackets	Indicates optional values. Example: [ a   b ] indicates that you can choose a, b, or nothing.
{ } braces	Indicates required or expected values. Example: { a   b } indicates that you must choose either a or b.
vertical bar	Indicates that you have a choice between two or more options or arguments. Examples: [ a   b ] indicates that you can choose a, b, or nothing. { a   b } indicates that you must choose either a or b.

This document uses the following icons to draw attention to information:

Icon	Label	Description
	Note	Calls attention to important and/or additional information.
	Tip	Provides helpful information, guidelines, or suggestions for performing tasks more effectively.

Icon	Label	Description
	Caution	Warns the user of adverse conditions and/or consequences (e.g., disruptive operations).
	WARNING	Warns the user of severe conditions and/or consequences (e.g., destructive operations).

## Convention for Storage Capacity Values

Physical storage capacity values (e.g., drive capacity) are calculated based on the following values:

Physical Capacity Unit	Value
1 KB	1,000 bytes
1 MB	1,000 <sup>2</sup> bytes
1 GB	1,000 <sup>3</sup> bytes
1 TB	1,000 <sup>4</sup> bytes
1 PB	1,000 <sup>5</sup> bytes
1 EB	1,000 <sup>6</sup> bytes

Logical storage capacity values (e.g., logical device capacity) are calculated based on the following values:

Logical Capacity Unit	Value
1 KB	1,024 (2 <sup>10</sup> ) bytes
1 MB	1,024 KB or 1,024 <sup>2</sup> bytes
1 GB	1,024 MB or 1,024 <sup>3</sup> bytes
1 TB	1,024 GB or 1,024 <sup>4</sup> bytes
1 PB	1,024 TB or 1,024 <sup>5</sup> bytes
1 EB	1,024 PB or 1,024 <sup>6</sup> bytes
1 BLOCK	512 BYTES

## Getting Help

The Hitachi Data Systems Support Center staff is available 24 hours a day, seven days a week. To reach us, please visit the support Web site for current telephone numbers and other contact information:

<http://www.hds.com/services/support/>. If you purchased this product from an authorized HDS reseller, contact that reseller for support.

Before calling the Hitachi Data Systems Support Center, please provide as much information about the problem as possible, including:

- The circumstances surrounding the error or failure.

- The exact content of any error message(s) displayed on the host system(s).

## Comments

Please send us your comments on this document: [doc.comments@hds.com](mailto:doc.comments@hds.com). Include the document title, number, and revision, and refer to specific section(s) and paragraph(s) whenever possible.

Thank you! (All comments become the property of Hitachi Data Systems Corporation.)

# About Mainframe Agent

This chapter explains the purpose of Mainframe Agent. The chapter also lists Mainframe Agent installation requirements, and provides an example system configuration.

- [Why Use Mainframe Agent?](#)
- [Installation Requirements](#)
- [System Configuration Example](#)

## Why Use Mainframe Agent?

Mainframe Agent is a product you can use to display information about mainframe system storage on a GUI of Device Manager or Replication Manager. Mainframe Agent collects information about mainframe system storage in response to a request from Device Manager or Replication Manager, and then passes the collected information to Device Manager or Replication Manager.

Mainframe Agent allows you to manage both open system and mainframe system storage by using Device Manager only, thus reducing the work and cost of storage management.

Note that linkage with Replication Manager can be used to monitor PPRC copy pairs from Replication Manager.

## Installation Requirements

This section explains the requirements for using Mainframe Agent.

### Operating System Requirements

Mainframe Agent can be used with the following operating systems:

- OS/390 V2R10
- z/OS V1R1 to V1R11

If you want to connect Device Manager or Replication Manager to Mainframe Agent by using IPv6, the only versions of z/OS that can be used are V1R9 through V1R11.



#### Caution:

- VM environments are not supported.
  - The devices in the alternate subchannel set are not supported.
- 

### Application Software Requirements

The following table lists the Mainframe Agent.

**Table 1-1 Programs Required to Use Mainframe Agent**

Program Name	Required	Overview	Description
IBM Communications Server (standard OS component)	Required	Communication program	None
Security Server (RACF)	Required	IBM security management product	None
TSO/E REXX (standard OS component)	Required	Prerequisite program for executing Mainframe Agent	None

Program Name	Required	Overview	Description
TSO/E (standard OS component)	Required		None
IBM Library for REXX on zSeries Release 4 (FMID HWJ9140) or IBM Library for REXX on zSeries Alternate Library (FMID HWJ9143)	Required		If neither of the libraries exists, a REXX alternate library (FMID HWJ9143, JWJ9144) is required. For z/OS V1R9 or later, the REXX alternate library is a standard OS component.
Device Manager	Required	Hitachi Command Suite product. Required to view the information about the storage managed by a mainframe host.	Use version 7.0.
Replication Manager	Optional	Hitachi Command Suite product. Required to monitor the statuses of PPRC copy pairs.	Use version 7.0.
IBM HTTP Server for z/OS	Optional	Optional product bundled with WebSphere Application Server for z/OS. Required when connecting to Device Manager or Replication Manager by using IPv6.	Use version 6.1.

## Prerequisite Equipment

Mainframe Agent can be used with the following storage systems:

- Lightning 9900V Series
- Hitachi USP
- Universal Storage Platform V/VM
- Virtual Storage Platform

## System Configuration Example

The following kinds of configurations exist:

- Device Manager is used to view storage information managed by the mainframe host
- Replication Manager is used to monitor the statuses of PPRC copy pairs managed by the mainframe host

- Device Manager is used to view storage information managed by the mainframe host, and Replication Manager is used to monitor the statuses of PPRC copy pairs managed by the mainframe host

## Using Device Manager to View Storage Information

Mainframe Agent and Device Manager can be linked so that storage information managed by the mainframe host can be displayed on a GUI.

The following figure shows a configuration example for using Device Manager to view storage information managed by the mainframe host.

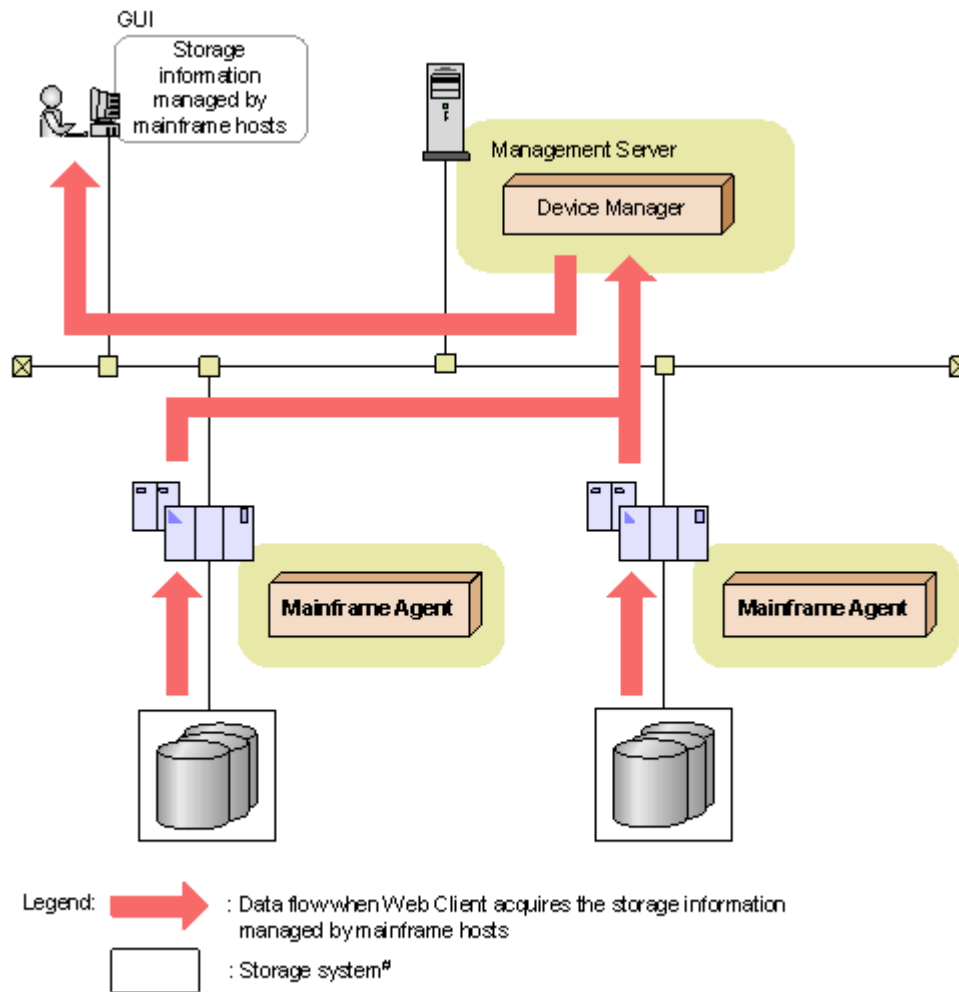
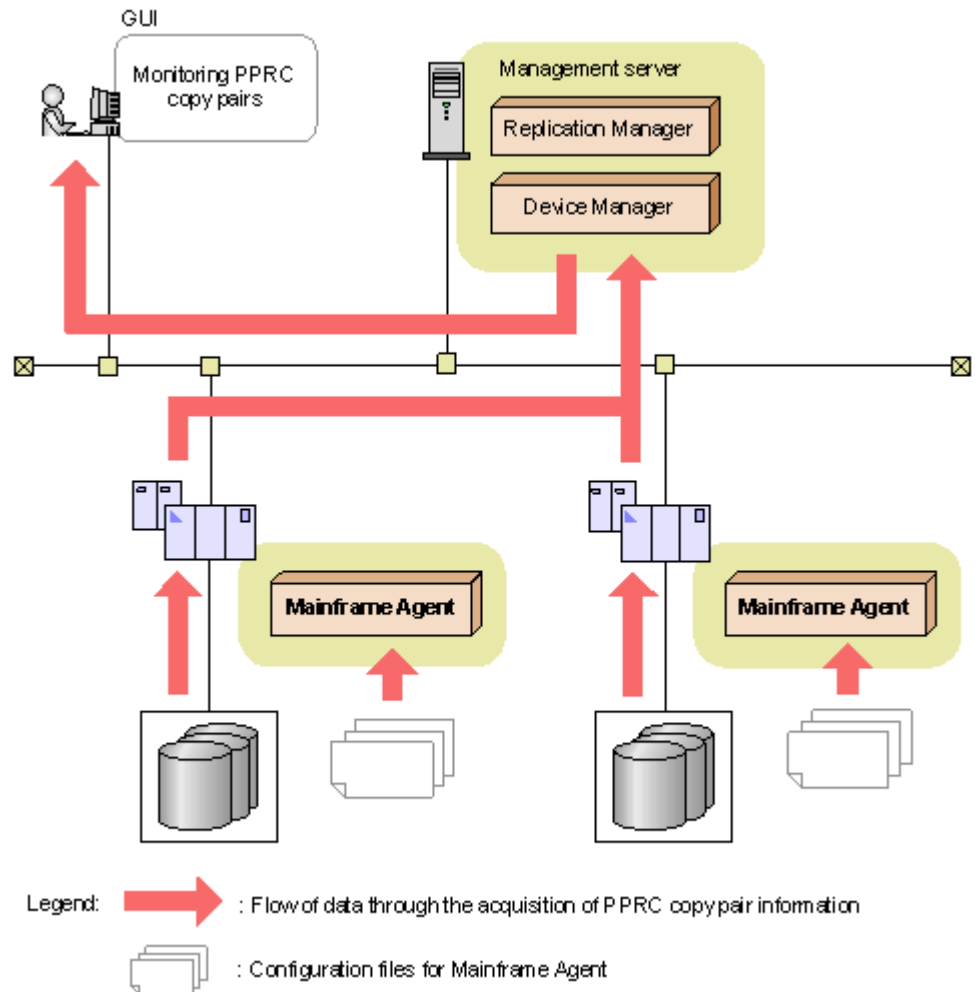

**Figure 1-1 Mainframe Agent Configuration with Hitachi Command Suite products**



## Using Replication Manager to Monitor PPRC Copy Pairs

PPRC copy pair statuses can be monitored from Replication Manager. The following figure shows a configuration example for using Replication Manager to monitor PPRC copy pairs.

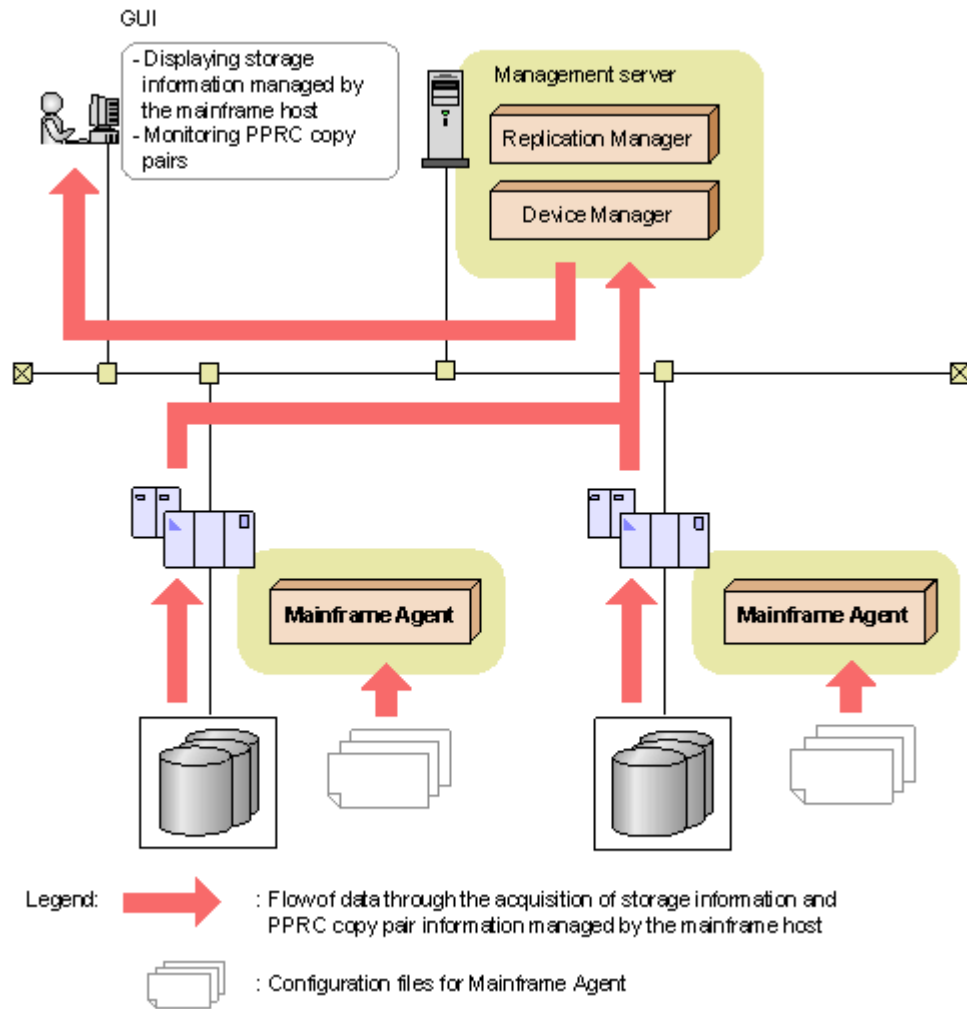

**Figure 1-2 Configuration for Using Replication Manager to Monitor PPRC Copy Pairs**

The Mainframe Agent disk configuration definition file and copy group definition file are required for monitoring the statuses of PPRC copy pairs. For details, see [Using Replication Manager to Monitor PPRC Copy Pairs on page 4-4](#).

## Using Device Manager to View Storage Information and Replication Manager to Monitor PPRC Copy Pairs

Following is a configuration example for using Device Manager to view storage information managed by the mainframe host and using Replication Manager to monitor PPRC copy pairs managed by the mainframe host.



**Figure 1-3 Configuration for Using Device Manager to View Storage Information Managed by the Mainframe Host and Using Replication Manager to Monitor PPRC Copy Pairs**

Mainframe Agent configuration files (disk configuration definition file and copy group definition file) are required for monitoring the statuses of PPRC copy pairs. For details, see [Using Replication Manager to Monitor PPRC Copy Pairs on page 4-4](#).

# Installing Mainframe Agent

This chapter provides an overview of installing Mainframe Agent, describes pre-installation checks, and explains the installation and upgrade procedures.

- [Installation Overview](#)
- [Pre-installation Checks](#)
- [Installation Procedure](#)
- [Upgrading Mainframe Agent](#)

# Installation Overview

The following figure provides an overview of installing Mainframe Agent.

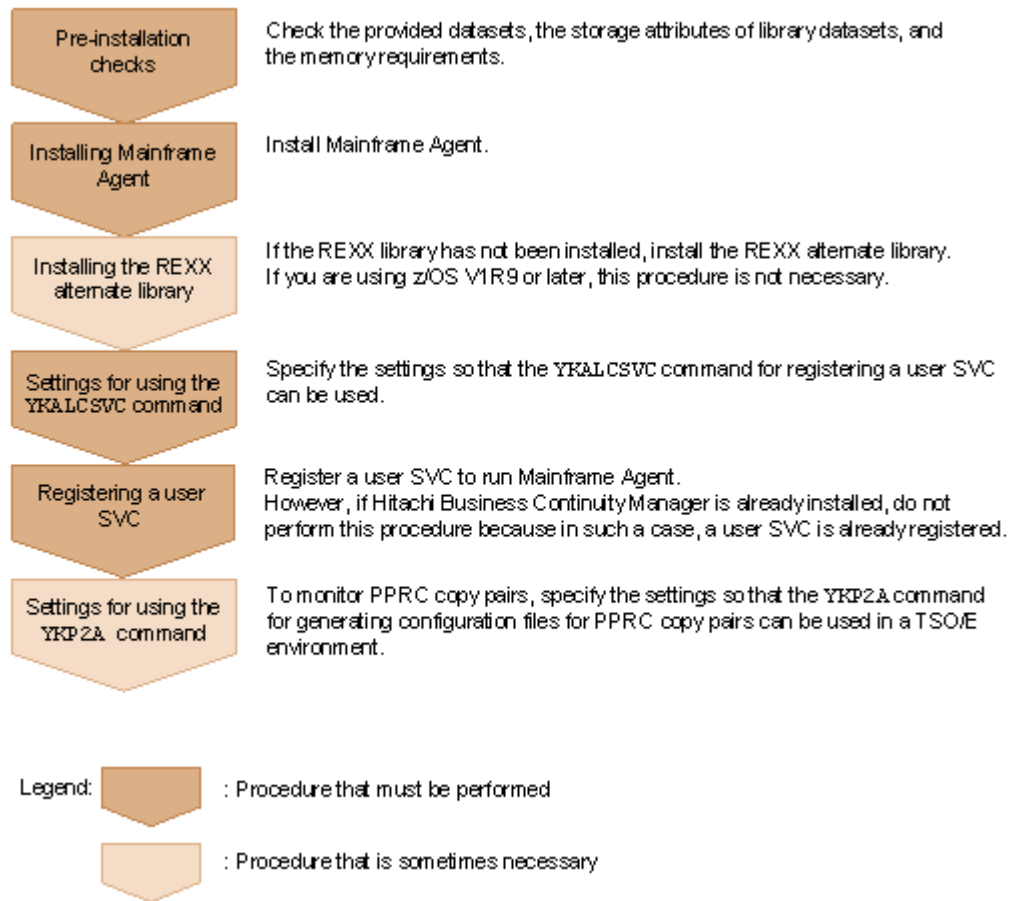

**Figure 2-1 Overview of Installing Mainframe Agent**

## Pre-installation Checks

This section describes the items that you need to check before installing Mainframe Agent.

## Provided Datasets

The following table lists the datasets that are on the installation CD-ROM.

**Table 2-1 Datasets Stored on the Installation CD-ROM**

Name of Dataset on Installation CD-ROM	Library Type	Description
MAGENT.Vnnnn.SAMPLIB.XMIT	SAMPLIB	Sample file provided in the standard package (the initialization parameters and startup cataloged procedures for Mainframe Agent)

Name of Dataset on Installation CD-ROM	Library Type	Description
MFAGENT.Vnnnn.LINKLIB.XMIT	LINKLIB	Load module for Mainframe Agent
MFAGENT.Vnnnn.LPALIB.XMIT	LPALIB	SVC module
MFAGENT.Vnnnn.PROCLIB.XMIT	PROCLIB	Cataloged procedure
MFAGENT.Vnnnn.EXECLIB.XMIT	EXECLIB	REXX Exec for Mainframe Agent
MFAGENT.Vnnnn.SMPMCS.XMIT#	REXX alternate libraries	SMP/E control statements for REXX alternate libraries
IBM.HWJ9143.F1.XMIT#		REXX alternate library linkage parameters and built-in sample JCL
IBM.HWJ9143.F2.XMIT#		Object module for REXX alternate libraries
IBM.HWJ9143.F3.XMIT#		Message library for REXX alternate libraries
IBM.JWJ9144.F1.XMIT#		Japanese language functionality for REXX alternate libraries
YKAGALLO.JCL (uncompressed text file)	Installation JCLs	Installation JCL for Mainframe Agent (allocates space for the datasets to be transferred)
YKAGINST.JCL (uncompressed text file)		Installation JCL for Mainframe Agent (allocates space for the execution datasets and extracts the datasets to the space allocated for them)

Note: In the above table, the *nnnn* portion of *Vnnnn* varies depending on the version.

# These datasets are not required if you are using z/OS V1R9 or later. They are required only if you are using a version earlier than z/OS V1R9 and you want to use the REXX alternate library.

## Storage Attributes of Library Datasets

When you run an installation JCL, Mainframe Agent is registered in the library datasets with the storage attributes shown in the following table.

**Table 2-2 Storage Attributes of Library Datasets**

Library Type	DSORG	RECFM	LRECL (bytes)	BLKSIZE (bytes)
SAMPLIB (sample library)	PO	FB	80	3,120
LINKLIB (load library)	PO	U	--	6,144
LPALIB (load library)	PO	U	--	6,144
PROCLIB (cataloged procedure library)	PO	FB	80	3,120

Library Type	DSORG	RECFM	LRECL (bytes)	BLKSIZE (bytes)
EXECLIB (REXX Exec library)	PO	FB	80	3,120

Legend:

- PO: Partitioned dataset
- FB: Fixed length block record
- U: Unfixed record

## Memory Requirements

The following shows the memory requirements for using the Mainframe Agent. The amount of required memory is expressed in KB. Note that sections within the formula enclosed in upward arrows indicate values whose decimal components are to be rounded up.

### For linkage with Device Manager:

- For a user region of less than 16 MB: 2,048 KB
- For an extended user region of 16 MB or more:  
 $3,072 \text{ KB} + D \text{ KB} + \uparrow(64 \times \text{number-of-specified-DEVN-parameters}) \div 1,024 \uparrow \text{ KB}$   
 Where  $D$  is the largest number of devices specified among the DEVN initialization parameters.

### For linkage with Replication Manager:

- For a user region of less than 16 MB: 2,048 KB
- For an extended user region of 16 MB or more:  
 $6,000 + A + \uparrow(512 \times \text{number-of-specified-PREFIX-parameters}) \div 1,024 \uparrow + \uparrow(64 \times \text{number-of-specified-DEVN-parameters}) \div 1,024 \uparrow \text{ KB}$   
 Where  $A$  is the larger of  $(1.5 \times D)$  and  $(3 \times P)$ .  
 Where  $D$  is the largest number of devices specified among the DEVN initialization parameters.  
 Where  $P$  is the greatest number of pairs of the copy groups used by Mainframe Agent.

## Installation Procedure

This section explains how to install Mainframe Agent.

### Installing Mainframe Agent

The following figure shows the workflow of installing Mainframe Agent.

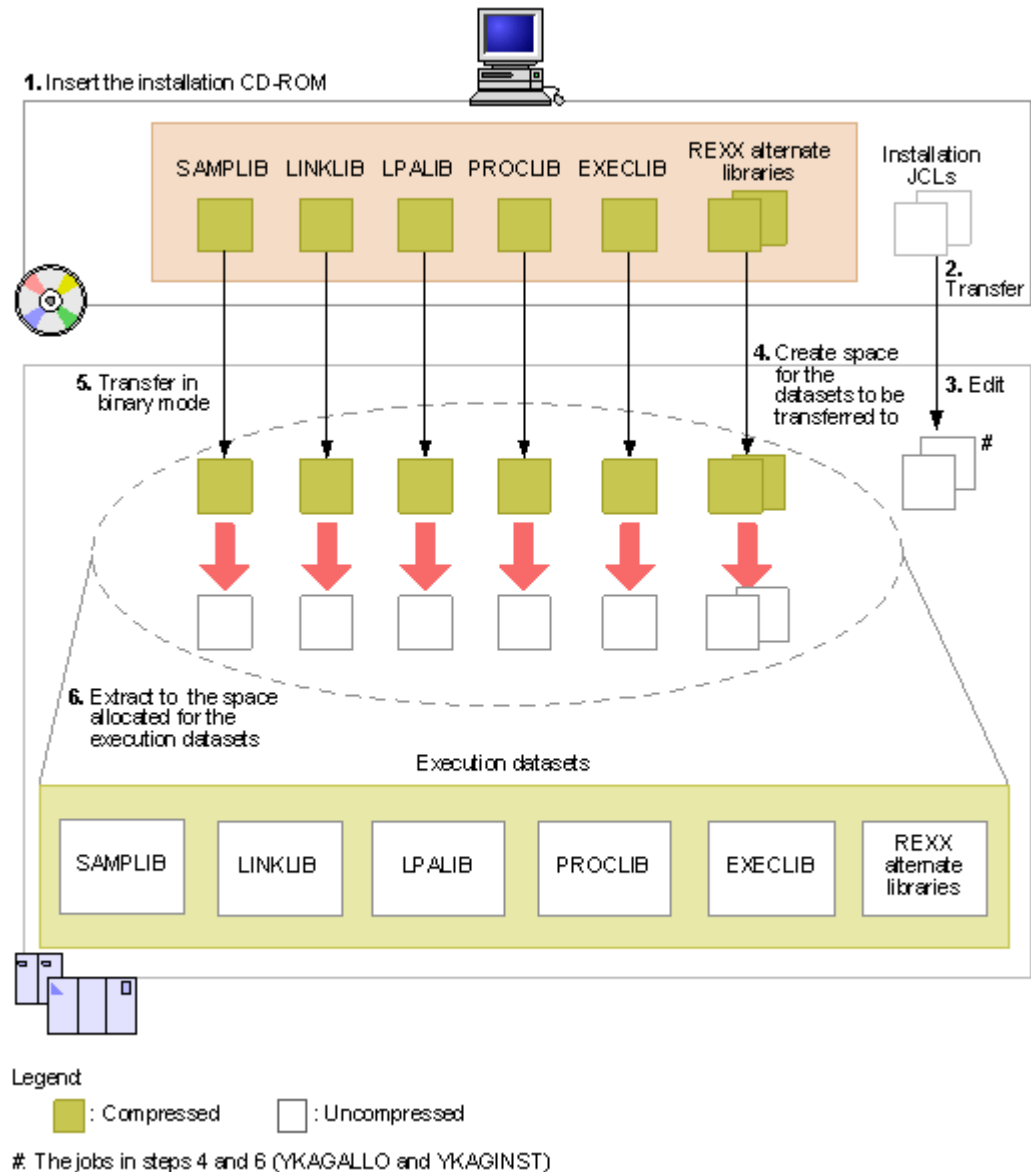

**Figure 2-2 Workflow of installing Mainframe Agent**

The following task outlines the installation of the Mainframe Agent. The numbers in the procedure correspond to the numbers in [Figure 2-2 Workflow of installing Mainframe Agent on page 2-5](#).

To install Mainframe Agent:

1. Insert the installation CD-ROM.
2. From the PC and using ASCII, transfer the following installation JCLs to a host machine:
  - JCL (YKAGALLO) for allocating space for the datasets on the CD-ROM that are to be transferred.
  - JCL (YKAGINST) for allocating space for and extracting the datasets to be executed.

3. Edit the JCLs transferred in step 2 to match your installation environment.  
For details, see the header comments in the JCLs.
4. Create space for the datasets to be transferred (execute the edited `YKAGALLO` job).  
  
The `YKAGALLO` job creates the sequential dataset space for transferring the Mainframe Agent object archive and the REXX alternate library archive to the host machine.
5. From the PC, transfer in binary mode the Mainframe Agent object archive and the REXX alternate library archive to the transfer dataset space allocated on the host machine.  
  
You need to transfer the REXX alternate library archive only if you plan to install a REXX alternate library.
6. Extract objects and libraries to the space allocated for the execution datasets (execute the edited `YKAGINST` job).  
  
The `YKAGINST` job allocates the execution dataset space, and extracts the objects and libraries from the transfer dataset archives to the execution dataset space.

## Installing the REXX Alternate Libraries

If you do not have one of the following REXX libraries, you need the REXX alternate library (FMID: HWJ9143, JWJ9144). The MCS (Modification Control Statements) corresponding to this FMID are stored in the `MFAGENT.Vnnnn.SMPMCS.XMIT` dataset listed in [Table 2-1 Datasets Stored on the Installation CD-ROM on page 2-2](#).

- IBM Library for REXX on zSeries Release 4 (FMID HWJ9140)
- IBM Library for REXX on zSeries Alternate Library (FMID HWJ9143)

For details on how to install the REXX alternate library, see Chapter 6 in the manual *Program Directory for IBM Library for REXX on zSeries Alternate Library* (GI10-3243-01).

## Settings for Using the YKALCSVC Command

The `YKALCSVC` command registers the user `SVC`, and is started by the OS `START` command.

To use the `YKALCSVC` command:

1. Define the `LINKLIB` library (the load library of Mainframe Agent) in the `PROGXX` parmlib member, and then register APF authorization by using the `SETPROG APF,ADD` command.
2. Specify the `LINKLIB` library (the load library of Mainframe Agent) in the cataloged procedure of the `YKALCSVC` command by using the `STEPLIB DD` statement.
3. Perform either of the following:



- Link the cataloged procedure library of Mainframe Agent to the IEFPSI dd name of the MSTJCLxx parmlib member.
- Copy the YKALCSVC member from the cataloged procedure library of Mainframe Agent to the user PROCLIB.

Once you have added the YKALCSVC command in the COMMNDXX parmlib member, it is automatically executed at the time of an IPL.

The following shows the YKALCSVC command format. For details on the symbols used to explain the command syntax, see [Table A-1 Symbols Used in Command Explanations on page A-2](#). For details on the command syntax elements, see [Table A-2 Command Syntax Elements on page A-2](#).

#### Format

```
START YKALCSVC[, PARM='{SVC-number | DELETE}']
```

#### Function

Registers or deletes a user SVC.

#### Parameters

*SVC-number* ~ <numeric characters> ((200 to 255))

Specifies an SVC number to assign to a user SVC.

DELETE

Specified to delete a user SVC.

If you omit the optional PARM= part of the command, an unused SVC number between 200 and 255 is assigned.

#### Return Codes

Used to indicate task status, as shown in the following table.

**Table 2-3 YKALCSVC Command Return Codes List**

Return code	Meaning
0	The command ended normally.
4	The SVC number is already registered.
16	Registration or deletion of the SVC number failed.
20	Processing stopped due to an error (the specified value or execution environment is invalid).

## Registering a User SVC

You must use one of the following methods to register the user SVC:

- Registration using the IEASVCXX parmlib member
- Registration using the YKALCSVC command

If you use the IEASVCXX parmlib member to perform registration, you must reload the system (that is, perform an initial program load (IPL)). If you are unable to perform an IPL while the system is running, use the YKALCSVC command to perform registration.



**Caution:** When Hitachi Business Continuity Manager is installed, do not register a user SVC.

## Using the IEASVCxx Parmlib Member to Register

To register the user SVC:

(For details on steps 2 and 4, see *MVS Initialization and Tuning Reference*.)

1. Choose a number between 200 and 255 to assign to the user SVC.
2. Insert the following `SYMDEF` statement (`&YKSVCNO` system symbol) into the `IEASYMXX` parmlib member:

```
SYMDEF (&YKSVCNO='SVC-number')
```

For the `SVC-number`, specify a decimal number between 200 and 255.

3. Use one of the following methods to link the `LPALIB` library of Mainframe Agent to `LPALST`:
  - Define the `LPALIB` library of Mainframe Agent in the `LPALSTXX` parmlib member. For details, see the *MVS Initialization and Tuning Reference*.
  - Use the `SETPROG LPA` command to dynamically link the `LPALIB` library of Mainframe Agent to `LPALST`. For details, see the *MVS System Commands*.
4. Define the following `SVC Parm` statement in the `IEASVCxx` parmlib member.

```
SVC Parm SVC-number, REPLACE, TYPE (3), EPNAME (JYUASVC)
```

5. Perform re-IPL with the `CLPA` parameter specified.

## Using the YKALCSVC Command to Register

The following shows how to execute the `YKALCSVC` command. For details on the format of the `YKALCSVC` command, see [Settings for Using the YKALCSVC Command on page 2-6](#).

When the system starts or before you use Mainframe Agent, execute the `YKALCSVC` command to register a user SVC.

Execute the command as follows with the SVC number specified:

```
START YKALCSVC, PARM='SVC-number'
```

An error is returned if another user SVC is already assigned to the SVC number specified here.

By omitting the `PARM` parameter, an unused SVC number between 200 and 255 is assigned. For example:

```
START YKALCSVC
```

To delete a user SVC, specify `DELETE` as the parameter and execute `YKALCSVC` command. For example:

```
START YKALCSVC, PARM='DELETE'
```



### Caution:

- If you delete a user SVC using the `YKALCSVC` command while Mainframe Agent is running, storage information may not be sent to Device Manager or Replication Manager correctly.
- If you register a user SVC using the `YKALCSVC` command while Mainframe Agent is running, any already-executing CLI command will continue to execute in the user SVC defined in the `IEASVCXX` parmlib member. The newly registered user SVC becomes available once a request is issued from Device Manager or Replication Manager.
- The user SVC registered with `YKALCSVC` command is lost when an IPL is performed. Before you perform another IPL, we recommend you specify one of the following settings:
  - Add the `YKALCSVC` command to the `COMMNDXX` parmlib member; so that the user SVC is automatically registered each time an IPL is performed.
  - Define the user SVC in the `IEASVCXX` parmlib member, and then, from the next IPL, use the registered user SVC.
- If you delete a user SVC routine registered with the `YKALCSVC` command of an earlier Mainframe Agent version, use the `YKALCSVC` command of an earlier Mainframe Agent version. You must be careful when upgrading Mainframe Agent in a system containing multiple Mainframe Agent versions.

## Settings for Using the YKP2A Command

Mainframe Agent provides the `YKP2A` command, which is one of the TSO/E commands.

To use the `YKP2A` command in a TSO/E environment:

1. Link `EXECLIB` (REXX Exec library) to the `SYSEXEC` dd name.
2. Link `LINKLIB` (load library) to the `TSOLIB` dd name.

## Upgrading Mainframe Agent

This section explains how to upgrade Mainframe Agent.

### Notes for Upgrading

If you upgrade Mainframe Agent from version 5.7 or earlier to version 6.0 or later, you need to define one of the following profiles in the `FACILITY` class of the Resource Access Control Facility (RACF), and then grant the view permission for the defined profile to the administrator user ID:

- STGADMIN.YKA.BCM.YKQUERY profile
- STGADMIN.YKA.BCM.COMMANDS profile

For details, see [Setting Up the Resource Access Control Facility \(RACF\) on page 3-3](#).

## Checks Before Upgrading

### Checking Whether to Upgrade Device Manager

Because Mainframe Agent is provided with Device Manager, make sure that you upgrade the server and mainframe hosts at the same time.

### Checking the User SVC Number

Check the user SVC number because you must assign the same number after upgrading. The method of checking the user SVC number varies depending on whether the user SVC was registered with the `YKSETENV` command or the `IEASVCXX` parmlib member.

- When the user SVC was registered by using the `YKSETENV` command  
Check the value specified in the `YKALCSVC` command parameter.
- When the user SVC was registered by using the `IEASVCxx` parmlib member  
Check the value set in the `&YKSVCNO` system symbol.

## Backing Up Datasets

Back up the following datasets:

- Cataloged procedure for startup (standard member name: `YKAGENTD`)
- Initialization parameters (standard member name: `YKPRM00`)
- Datasets in which Mainframe Agent was installed

## Pre-Upgrade Procedure

### Deleting the User SVC

When you upgrade the Mainframe Agent, you must delete the user SVC of an earlier Mainframe Agent version before installing the new version.

If the user SVC was registered by using the `YKALCSVC` command, use the `YKALCSVC` command to delete the user SVC.

If the user SVC was registered by using the `IEASVCxx` parmlib member, you cannot use the `YKALCSVC` command to delete the user SVC. Instead, you must complete the following procedure. For details on steps 1 and 2, see the *MVS Initialization and Tuning Reference*.

1. Comment out the `SYMDEF` statement for the `&YKSVCNO` system symbol in the `IEASYMxx` parmlib member as follows:

```
/* SYMDEF (&YKSVCNO='SVC-number') */
```

2. Use the `IEASVCxx` parmlib member to disable (comment out) the `SVCPARM` statement for the `JYUASVC` module.

```
/* SVCPARM SVC-number, REPLACE, TYPE (3), EPNAME (JYUASVC) */
```

3. Perform IPL with the `CLPA` parameter specified.

## Removing the Concatenation of Cataloged Procedure Libraries

Remove the dataset concatenation of the library shown in the table below. If you copied the `PROCLIB` library members to a user `PROCLIB`, delete the copied members.

**Table 2-4 Library for Which the Dataset Concatenation Must Be Removed Before Performing an Upgrade**

dd Name	Library Name
IEFPDSI	Cataloged procedure library <code>PROCLIB</code>

## Removing the Concatenation of Load Libraries

Remove the `LPALIB` load library linked to `LPALST`.

## Upgrading Mainframe Agent

As described in [Pre-installation Checks on page 2-2](#) and [Installation Procedure on page 2-4](#), install a new version of Mainframe Agent.

If the installation of IBM Library for REXX on zSeries Release 4 (FMID HWJ9140) or IBM Library for REXX on zSeries Alternate Library (FMID HWJ9143) has been completed, you do not need to perform the procedure described in [Installing the REXX Alternate Libraries on page 2-6](#).

## Checking Settings After Upgrading

After upgrading Mainframe Agent, make sure that the new settings are the same as those checked in [Checks Before Upgrading on page 2-10](#).



## Setting Up Mainframe Agent

This chapter explains how to set up the environment to acquire storage information using the Mainframe Agent.

- [Setting the TCP/IP Port Number](#)
- [Setting the Security](#)
- [Setting Up IBM HTTP Server](#)
- [Creating Initialization Parameters](#)
- [Creating a Cataloged Procedure for Startup](#)
- [Setting Up the Device Manager Environment](#)
- [Setting Up the Replication Manager Environment](#)

## Setting the TCP/IP Port Number

Before performing this procedure, you need to reserve a port number for communicating with Device Manager or Replication Manager.

For a job that starts the Mainframe Agent, set the UNIX service's usage attributes (open a port for receiving). For details, refer to the *Communications Server: IP Configuration Reference*.

Set the port number in the TCP/IP environment settings file (`PROFILE.TCPIP` profile, the definition file related to server functions in the TCP/IP address space).

In the `PORT` definition of the `PROFILE.TCPIP` profile, specify the member name or identification name of the Mainframe Agent start job. For details about the identification name, see [Operands on page 4-18](#).

For the port number to be used by the `YKAGENTD` job, you cannot specify a number that is already being used by another job. Specify a port number that is not being used in the system.

Example of specifying the port number

The following specification sets the port number as 24042:

```
24042 TCP YKAGENTD ;YKAGENTD START NAME
```



**Caution:** The Mainframe Agent requires 2 sockets of IBM Communications Server (OS standard equipment). Make sure that the total number of sockets does not exceed the maximum number of sockets that IBM Communications Server can provide, keeping in mind the number of sockets required for other services that IBM Communications Server handles. For details about the maximum number of sockets that IBM Communications Server can provide, see the *Communications Server IP Configuration Guide*.

---

## Setting the Security

This section describes how to set the security.

### Setting the Dataset Security

When a Mainframe Agent is linked to Replication Manager, the Mainframe Agent job references the Mainframe Agent's configuration files. Therefore, be sure to grant the Mainframe Agent job `READ` permission for the configuration files that are accessed by the Mainframe Agent job.

The configuration files to which `READ` permission is to be granted are the following datasets, which have their prefixes specified by the `YKP2A` command:

- Disk configuration definition file
- Copy group definition file



- Command device definition file

## Setting Up the Resource Access Control Facility (RACF)

To enable Mainframe Agent communications, set an environment for the security program (RACF).

To enable use of UNIX services, use the `RACF` command from TSO/E to define the management user and management group IDs held by the OMVS segment in the RACF `STARTED` class of the Mainframe Agent cataloged procedure for startup. The following is an example of using the TSO/E command with the `STARTED` class:

Example of setting using the TSO/E command:

```
->SETROPTS GENERIC(STARTED)
->RDEFINE STARTED YKAGENTD.* STDATA(USER(user-ID) GROUP(group-ID)
  TRUSTED(YES))
->SETROPTS RACLIST(STARTED) REFRESH
```

To start the Mainframe Agent, you need to define one of the following profiles in the RACF `FACILITY` class, and then grant the view permission for the defined profile to the administrator user ID:

In addition, before the `YKP2A` command is executed, grant view permissions for one of the following profiles to the user ID of the user who intends to execute the command:

- `STGADMIN.YKA.BCM.YKQUERY` profile
- `STGADMIN.YKA.BCM.COMMANDS` profile

Before executing the `YKP2A` command, grant the view permission for one of these profiles to a user who can execute the command. For details about granting the view permission, see the *Security Server RACF Security Administrator's Guide*. For details on the `YKP2A` command, see [YKP2A Command on page 4-10](#).

Following is an example of using the TSO/E command with the `FACILITY` class:

```
->SETROPTS CLASSACT(FACILITY)
->RDEFINE FACILITY STGADMIN.YKA.BCM.YKQUERY UACC(NONE)
->PERMIT STGADMIN.YKA.BCM.YKQUERY CLASS(FACILITY) ID(user-ID) ACCESS(READ)
```

To improve the execution performance of the Mainframe Agent, activate the `RACLIST` function (in-storage profiles) for the `FACILITY` class using one of the following commands.

If the `FACILITY` class has not been activated by `RACLIST`:

```
SETROPTS RACLIST(FACILITY)
```

If the `FACILITY` class has already been activated by `RACLIST`:

## Setting Up IBM HTTP Server

This section explains how to set up IBM HTTP Server in order to establish IPv6 connections, and it also explains how to collect logs.

### Settings for Connecting via IPv6

When Device Manager or Replication Manager is connected to Mainframe Agent via IPv6, IBM HTTP Server is required to act as a reverse proxy server. When the reverse proxy server receives a request from Device Manager or Replication Manager via IPv6, it changes the request to IPv4 format and then provides the request to Mainframe Agent, which acts as the origin server.

The following shows a configuration example of when Device Manager or Replication Manager connects to Mainframe Agent via IPv6.

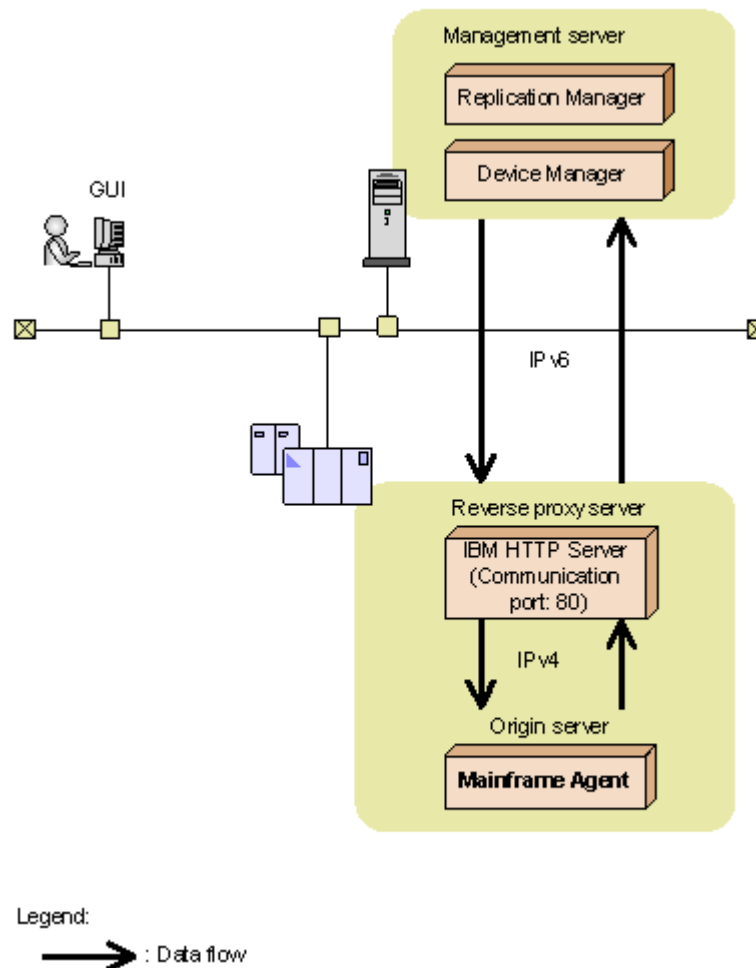

**Figure 3-1 Example Configuration When Using IPv6 to Establish Connections**

To set up IBM HTTP Server to run as a reverse proxy server, specify the settings described in the following table for the `httpd.conf` file.

**Table 3-1 Settings to Be Specified in the `httpd.conf` File for IPv6 Connections**

Directive to Be Specified	Description of Directive, and Values to Be Specified
<code>CacheDisable</code>	Specify this directive so that the cache function for requests directed to the Mainframe Agent is disabled.
<code>KeepAlive</code>	Specify this directive to disable the KeepAlive function.
<code>Listen</code>	Specify a standby port in IPv6 as shown below. The port number can be changed: <code>Listen [::]:80</code>
<code>LoadModule</code>	Add the following modules to the list so that the reverse proxy function will be enabled: <code>proxy_module modules/mod_proxy.so</code> <code>proxy_http_module modules/mod_proxy_http.so</code>
<code>ProxyPass</code> and <code>ProxyPassReverse</code>	Specify the following options to set up Mainframe Agent to act as the origin server for Device Manager or Replication Manager: <ul style="list-style-type: none"> <li>The host name or IPv4 address of the host that is running Mainframe Agent</li> <li>The port number that was specified for the <code>PORT</code> parameter when initially setting up Mainframe Agent</li> </ul> The following example shows how to specify the options: <code>ProxyPass / http://host-name-or-IPv4-address:port-number</code> <code>/ProxyPassReverse / http://host-name-or-IPv4-address:port-number/</code>
<code>Timeout</code>	This directive is used to specify how long to wait before issuing a timeout. Specify a value greater than the timeout values of Replication Manager ( <code>bcmif.socketTimeout</code> ) and Device Manager ( <code>host.mf.agent.connection.timeout</code> ).

## Collecting the Trace Log

To collect error logs and access logs between either Device Manager or Replication Manager and IBM HTTP Server, use the log function of IBM HTTP Server.

As for whether to collect logs of IBM HTTP Server, follow the instruction from the Web administrator. Note that, if you do not collect logs, it might be difficult to determine the cause of an access error.

## Creating Initialization Parameters

This section describes how to create the initialization parameters for setting up the environment that is required to start the Mainframe Agent. `YKPRM00` is

a member of the initialization parameter samples registered in the sample library during initialization. Adjust the parameters to fit your environment.

Create a dataset to hold the initialization parameters by specifying the following attributes:

- LRECL: 80
- BLKSIZE: Multiple of 80
- RECFM: Fixed-length or blocked fixed-length record
- DSORG: Sequential or partitioned dataset

## How to Use the SETINIT Command

This subsection explains the format of the `SETINIT` command, that sets the initialization parameters. For details about the symbols used in command explanations, see [Table A-1 Symbols Used in Command Explanations on page A-2](#). For details about the command syntax elements, see [Table A-2 Command Syntax Elements on page A-2](#).

```
△0SETINIT[△1parameter]...
```

Specify a `SETINIT` command and parameters in columns 1 through 71. Any information specified in a column after column 72 is ignored.

You can specify more than one `SETINIT` command. You can specify different parameters for one `SETINIT` command, but cannot specify the same parameter more than once. If you specify the same parameters more than once for one `SETINIT` command, the last specified parameter is applied.

To specify the same parameter more than once, use a separate `SETINIT` command. If a parameter that cannot be specified more than once in separate `SETINIT` commands is specified in that way, the last specified parameter is applied.

For details about the specifiable parameters and whether they can be specified more than once using separate `SETINIT` commands, see [Details of Initialization Parameters on page 3-8](#).

Example of specifying the same parameter more than once for one `SETINIT` command:

If you specify the same parameter more than once for one `SETINIT` command, the last specified parameter is applied. Do not specify parameters as shown in this example.

In the following example, only `DEVN(7500,750F)` is applied, and `DEVN(7300,730F)` and `DEVN(7400,740F)` become invalid:

```
SETINIT DEVN(7300,730F) DEVN(7400,740F) DEVN(7500,750F)
```

Example of specifying the same parameter more than once for separate commands:

- If the parameter can be specified more than once for separate commands:

All the specified parameters are applied.

If you specify parameters as follows, `DEVN(7300,730F)`, `DEVN(7400,740F)`, and `DEVN(7500,750F)` are applied:

```
SETINIT DEVN(7300,730F)
SETINIT DEVN(7400,740F)
SETINIT DEVN(7500,750F)
```

- If the parameter cannot be specified more than once for separate commands:

The last specified parameter is applied.

If you specify parameters as follows, `RECVWAITTIME(180)` is applied:

```
SETINIT RECVWAITTIME(65535)
SETINIT RECVWAITTIME(180)
```

## Continuing to the Next Line

To continue a parameter onto the next line, enter a continuation symbol at the end of the line. The following table shows the continuation symbols.

**Table 3-2 Continuation Symbols**

Continuation Symbol	Continuation Method
Hyphen (-)	The hyphen is removed, and the parameter is continued in the leftmost column of the next line, retaining any contiguous spaces.
Plus sign (+)	The plus sign is removed, and the parameter is continued on the next line, removing any contiguous spaces.

Coding example for continuing parameters that contain contiguous spaces:

```
SETINIT-
  ▲ ▲DEVN(7300,730F)
```

If you continue to specify parameters by using a hyphen (-) as shown above, the command will be interpreted as follows:

```
SETINIT ▲ ▲DEVN(7300,730F)
```

Coding example for continuing parameters, removing contiguous spaces:

```
SETINIT DEVN(7300,+
  ▲ ▲730F)
```

If you continue to specify parameters by using a plus sign (+) as shown above, the command will be interpreted as follows:

```
SETINIT DEVN(7300,730F)
```

## Entering Comments

Enclose a comment in /\* and \*/. No comment can be entered inside a parameter.

Example of a valid comment:

```
/* COMMENT */  
SETINIT PORT(24042) /* COMMENT */
```

Example of an invalid comment:

If you specify a comment as follows, the text /\* ERROR COMMENT \*/ will be interpreted as a part of the parameter instead of being interpreted as a comment:

```
SETINIT DEVN(7300, + /* ERROR COMMENT */  
730F)
```







## Notes During Creation of Initialization Parameters

Do not specify an empty member as an initialization parameter when you start the Mainframe Agent. Although empty members do not result in an error, information cannot be returned to Device Manager or Replication Manager.

## Details of Initialization Parameters

This subsection explains details of initialization parameters.

### Format

```
SETINIT  
[  PORT (port-number) ]  
[  RECVWAITTIME (reception-wait-time) ]  
[  HOSTNAME ('host-identification-name') ]  
[  PREFIX ('prefix', 'local-site's-DAD-ID') ]  
[  DEVN (start-device-number, end-device-number) ]  
[  LOGLEVEL (output-level) ]
```

### Parameters

PORT (*port-number*) ~ <numeric characters> ((1-65535)) <<24042>>

Specifies the Mainframe Agent port for TCP/IP communication with Device Manager or Replication Manager. You cannot specify a port number that is being used by another job. Specify a port number that is not being used in the system.

RECVWAITTIME (*reception-wait-time*) ~ <numeric characters> ((0-65535))  
<<180>>

When TCP/IP communication with Device Manager or Replication Manager is performed, this parameter specifies the wait time (in seconds) from when a receive request is initiated to when data is received. A value of 0 means that the Mainframe Agent is to wait for data indefinitely.

HOSTNAME ('*host-identification-name*') ~ <1 to 50 alphanumeric characters>  
<<value specified for the &SYSNAME system symbol>>

Specify this parameter when Device Manager or Replication Manager needs to identify the Mainframe Agent. When the Mainframe Agent is running on more than one host, and a HOSTNAME (host identification name) value is duplicated in these hosts, Device Manager or Replication Manager cannot identify the host on which the target Mainframe Agent is running. To ensure that Device Manager or Replication Manager can identify the host on which the Mainframe Agent is running, specify a unique HOSTNAME value for each host.

When this parameter is omitted, the value of the &SYSNAME system symbol is assumed. For details about the &SYSNAME system symbol, refer to the *MVS Initialization and Tuning Reference*.

When the Mainframe Agent runs on more than one host and an &SYSNAME system symbol value is duplicated in these hosts, Device Manager or Replication Manager cannot distinguish between the hosts. When the &SYSNAME system symbol value is duplicated, make sure that HOSTNAME values are unique among the hosts.

#### Notes about Specifying the HOSTNAME Parameter:

When you specify the host name for reporting to Device Manager, do not specify the name of a host that is already being managed by Device Manager (including external connection ports that are being managed by Device Manager as hosts). To ensure that you do not specify such a host name, use one of the following methods:

- Ensure that DNS can resolve the host name you specify.
- If a host name that DNS can resolve is identical to a host name already managed by Device Manager, set the host identification name of the mainframe host for the HOSTNAME parameter, and then set the same host identification name in Device Manager.
- If neither of the above methods allows you to set a unique host name, change the host name of the host managed by Device Manager.
- If none of the above three methods allows you to set a unique host name, you can specify any host name.

PREFIX ('*prefix*', '*local-site's-DAD-ID*')

To collect Mainframe Agent information from Replication Manager, specify the prefix of the configuration file created by the `YKP2A` command. For details about the `YKP2A` command, see [YKP2A Command on page 4-10](#).

You can specify multiple `PREFIX` parameters. Specify multiple `PREFIX` parameters when the storage information to be acquired is information registered in multiple configuration files that have different prefixes, in an environment where Replication Manager and the Mainframe Agent are one-to-one.

*prefix* ~ <PREFIX string consisting of 1 to 16 characters>

Specifies the file name prefix of the Mainframe Agent configuration files that are used by Replication Manager. The disk configuration definition file with the prefix specified here, the volume information defined in the copy group definition file, and the copy group are provided to Replication Manager.

*local-site's-DAD-ID* ~ <DAD string consisting of 1 to 28 characters>

Specify the device address domain ID of the primary site specified for the `DAD` parameter of the `YKP2A` command.

#### Notes about Specifying the PREFIX Parameter

- Do not specify a nonexistent prefix or device address domain ID in the `PREFIX` parameter. Even though specifying a nonexistent prefix or device address domain ID does not result in an error during Mainframe Agent startup, an error will occur during a Replication Manager request.
- In the `PREFIX` parameter, do not specify any value other than the prefix of the configuration file. If multiple datasets correspond to the specified prefix (such as the `SYS1` prefix), Mainframe Agent processing might slow down.
- Do not specify multiple `PREFIX` parameters for the same prefix. The monitoring processing of Device Manager or Replication Manager might slow down.
- If you specify multiple `PREFIX` parameters, it will take time to switch the configuration files for each prefix during a Replication Manager request. Therefore, if there are many configuration files, we recommend that you aggregate prefixes in the configuration files so that there is only one `PREFIX` parameter, to shorten the access time for a request from or a response to Replication Manager.
- Do not edit the configuration file for the prefix specified for the `PREFIX` parameter, as this might cause display issues or errors with the Mainframe Agent configuration file information in Replication Manager.
- The access time for a Replication Manager request or response becomes longer according to the number of copy pairs defined in the copy group definition file that has the specified prefix. Therefore, specify the monitoring interval of Replication Manager to fit the environment (the host capability corresponding to the number of copy pairs).



DEVN (*start-device-number, end-device-number*) ~ <4 hexadecimal characters>

Specifies a range of devices from which to collect information when filtering the host volume information to be passed to Device Manager or Replication Manager. Specify the *start-device-number* and *end-device-number* in the ascending order of hexadecimal characters. If the DEVN parameter has not been specified before, DEVN(0000,FFFF) is assumed.

#### Notes about Specifying the DEVN Parameter

- To reduce the access time required for requests and replies from Device Manager or Replication Manager, we recommend that you specify a range of target devices from which information is collected.
- When you specify more than one DEVN parameter, even if there are duplicate devices, they are not eliminated, so make sure you avoid specifying such duplications.

LOGLEVEL (*output-level*) ~ <numeric character> ((0-2)) <<2>>

Specifies the log output level.

0

Logs are not output. If 0 is specified, it is difficult to determine the cause of a communication failure or an error that occurs during execution of a Mainframe Agent command.

1

Communication-related messages (YKY300I, YKY301I, YKY304I, and YKY307I) are output.

2

In addition to the messages that are output when LOGLEVEL(1) is specified, a YKY680I message indicating an error during execution of a Mainframe Agent command is output.

The following table shows the LOGLEVEL specification and the messages that are output.

**Table 3-3 LOGLEVEL Specification and the Output Messages**

LOGLEVEL	Output messages
0	No output
1	YKY300I, YKY301I, YKY304I, and YKY307I
2	YKY300I, YKY301I, YKY304I, YKY307I, and YKY680I

## Multiple Specifications of Initialization Parameters

The following table explains what results when multiple SETINIT commands are used to specify each initialization parameter:

**Table 3-4 Results of Multiple Specification of Initialization Parameters**

Parameter name	Results of multiple specification
PORT	If specified more than once, the last specified parameter is applied.
RECVWAITTIME	
HOSTNAME	
PREFIX	Permitted
DEVN	
LOGLEVEL	If specified more than once, the last specified parameter is applied.

## Examples of Specifying Initialization Parameters

This subsection provides examples of specifying initialization parameters used for linking to Device Manager or Replication Manager.

### When Connecting to Device Manager

This subsection explains how to specify initialization parameters when connecting Mainframe Agent to Device Manager.

The following example configuration is used to explain the specification method.

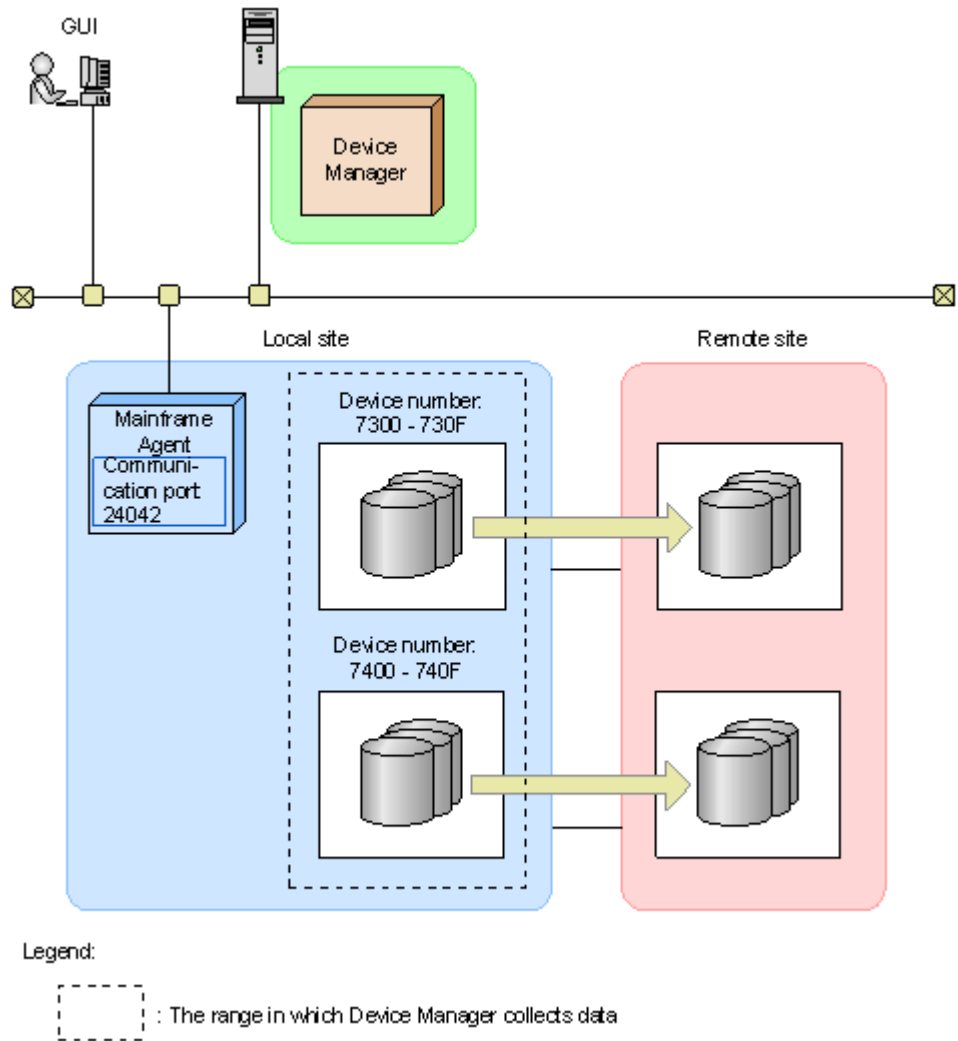

**Figure 3-2 Example Configuration for Connecting to Device Manager**

To connect Mainframe Agent to Device Manager in the configuration shown in [Figure 3-2 Example Configuration for Connecting to Device Manager on page 3-13](#), specify the values shown in the following table.

**Table 3-5 Settings to Be Specified To Connect to Device Manager**

Level of the Log Data to Be Output	Local Site		Remote Site
	Port Number	Device Number	
2	24042	7300 to 730F 7400 to 740F	No specification

The following shows an example of specifying the settings shown in [Table 3-5 Settings to Be Specified To Connect to Device Manager on page 3-13](#) for initialization parameters.

```

SETINIT LOGLEVEL(2)
SETINIT PORT(24042)
/* DEVN */
SETINIT DEVN(7300,730F)
SETINIT DEVN(7400,740F)

```

## When Connecting to Replication Manager

This subsection explains how to specify initialization parameters when connecting Mainframe Agent to Replication Manager.

The following example configuration is used to explain the specification method.

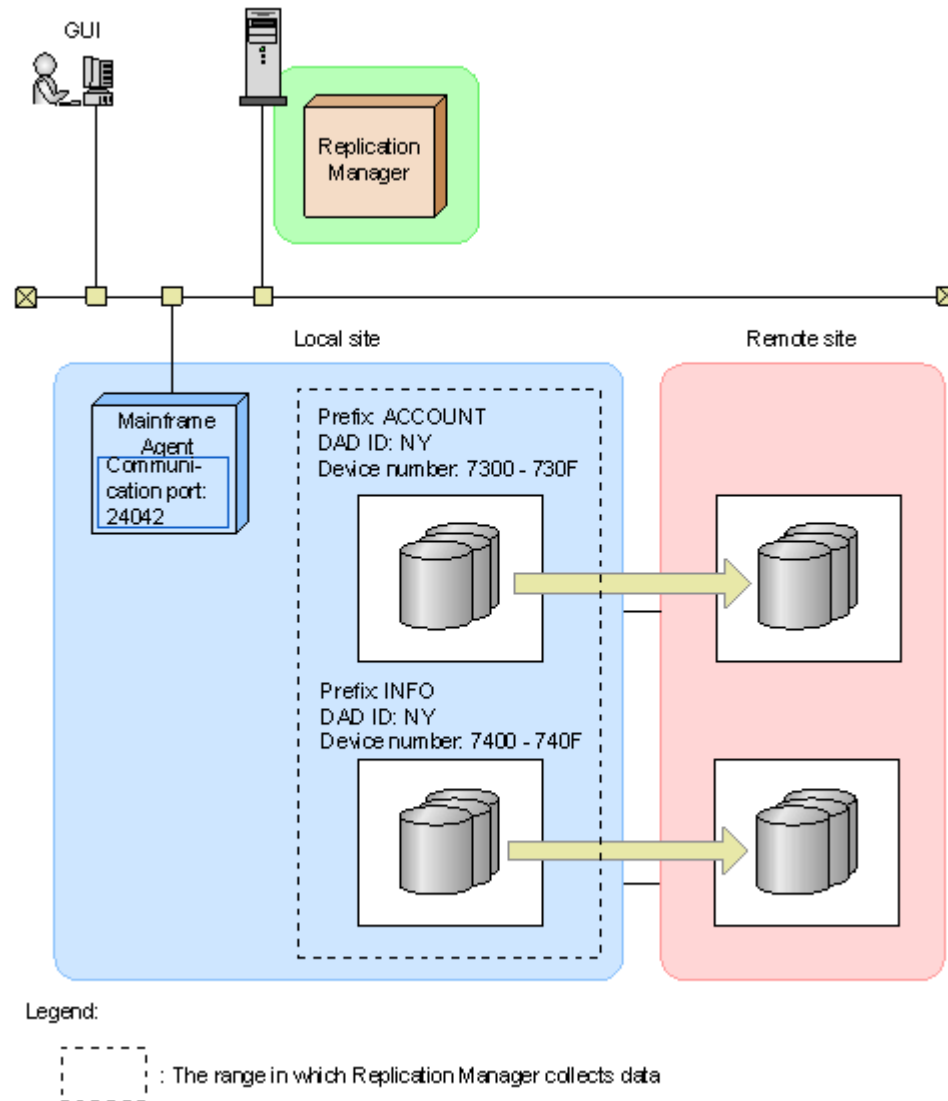

**Figure 3-3 Example Configuration for Connecting to Replication Manager**

To connect Mainframe Agent to Replication Manager in the configuration shown in [Figure 3-3 Example Configuration for Connecting to Replication Manager on page 3-14](#), specify the values shown in the following table.

**Table 3-6 Settings to Be Specified To Connect to Replication Manager**

Prefix	Local Site			Remote Site	
	Level of the Log Data to Be Output	Port Number	DADID		Device Number
ACCOUNT	2	24042	NY	7300 to 730F	No specification
INFO				7400 to 740F	

The following shows an example of specifying the settings shown in [Table 3-6 Settings to Be Specified To Connect to Replication Manager on page 3-15](#) for initialization parameters.

```

SETINIT LOGLEVEL(2)
SETINIT PORT(24042)
/* PREFIX */
SETINIT PREFIX('ACCOUNT','NY')
SETINIT PREFIX('INFO','NY')
/* DEVN */
SETINIT DEVN(7300,730F)
SETINIT DEVN(7400,740F)

```

## Examples of Initialization Parameter Analysis Results

When the Mainframe Agent starts, the results of the initialization analysis is output to the dataset specified in the `YKLIST DD` statement.

The following examples show results. In the result list, the *nn-nn* portion varies depending on the Mainframe Agent version.

- Result list with no error

```

*** AGENT nn-nn LISTING INFORMATION ***   DATE=2009-10-15 TIME=13:34:35
PAGE=0001

SETINIT PORT(24042)
/* DEVN */
SETINIT DEVN(7300,730F)
SETINIT DEVN(7400,740F)

```

- Result list with an error

This example shows an error condition where the end device number that is required for the first `DEVN` parameter is missing. The `YKY002I` message is displayed.

```

*** AGENT nn-nn LISTING INFORMATION ***   DATE=2009-10-15 TIME=16:09:53
PAGE=0001

SETINIT PORT(24042)
/* DEVN */

```

```
SETINIT DEVN(7300)
YKY002I INVALID INITIALIZATION PARAMETER: DEVN
SETINIT DEVN(7400,740F)
```

## Creating a Cataloged Procedure for Startup

This section explains how to create and change a cataloged procedure for starting Mainframe Agent.

### Standard Cataloged Procedure for Startup

The standard cataloged procedure for startup is registered into the sample library during installation. Copy the standard cataloged procedure for startup to the PROCLIB dataset of the JES (Job Entry Subsystem) startup procedure, and then modify the procedure to fit your environment.

### Standard Cataloged Procedure for Startup in the Expanded Format

- **Member name:** YKAGENTD  
In the sample JCL, the *nnnn* portion of *Vnnnn* varies depending on the version.

```
//YKAGENTD PROC MEMBER=YKPRM00
//*****
//*
//* ALL RIGHTS RESERVED. COPYRIGHT (C) 2006, 2010, HITACHI, LTD.
//*
//*****
//IEFPROC EXEC PGM=IKJEFT01,PARM=YKAGENTD,
//          TIME=1440,REGION=4096K
//YKPARM   DD DSN=MFAGENT.Vnnnn.SAMPLIB(&MEMBER),DISP=SHR
//YKLIST   DD DDNAME=IEFRDER
//SYSTSPRT DD DUMMY
//SYSTSIN  DD DUMMY
//SYSABEND DD SYSOUT=*
//SYSEXEC  DD DSN=MFAGENT.Vnnnn.EXECLIB,DISP=SHR
//STEPLIB  DD DSN=MFAGENT.Vnnnn.LINKLIB,DISP=SHR
```

### Description

#### 1. PROC statement

Specifies the member name of the initialization parameter that is used during the startup of the Mainframe Agent. The member specified in this statement is the default value. To use a non-standard member, execute the `START` command to change the member during the startup.

#### 2. EXEC statement

Specifies the following operands:

- `TIME` (CPU cut-off time) whose value is 1440.

- REGION (region size). To calculate this value, see [Memory Requirements on page 2-4.e](#)
3. YKPARAM DD statement  
Specifies the name of the dataset that contains the initialization parameters, and a member name for a partitioned dataset.
  4. YKLIST DD statement  
Specifies the dataset to which the initialization parameter analysis result is to be output. The specified dataset must have the following attributes:
    - LRECL: 121
    - BLKSIZE: Multiple of 121
    - RECFM: FBA
    - DSORG: Sequential dataset (and a member name for a partitioned dataset)
  5. SYSTSPRT DD statement  
Specifies DUMMY.
  6. SYSTSIN DD statement  
Specifies DUMMY.
  7. SYSABEND DD statement  
Specifies the location to which the dump is output when the Mainframe Agent terminates abnormally. SYSOUT=\* is specified in the standard cataloged procedure for startup. If the DUMMY output class is assigned as the output destination class for system messages in a job that is started by the START command, we recommend that you specify SYSOUT=SYSOUT-class-enabled-for-output, since the dump is not output with SYSOUT=\* specified.
  8. SYSEXEC DD statement  
Specifies the dataset that contains the REXX exec library.
  9. STEPLIB DD statement (optional)  
Specifies the dataset that contains the Mainframe Agent's load library. If Mainframe Agent's LINKLIB dataset is linked to the system's LINKLIB, you do not need to specify the STEPLIB DD statement.

## Notes

- Because the Mainframe Agent is a resident program that waits for client requests, specify TIME=1440 in the EXEC statement so that no timeout occurs. Additionally, specify Purge as the output class of the job log and system messages so that the output messages do not cause a shortage of spool space.

- If z/OS V1R3 or later is running, use the `JOB` statement keyword of the `START` command to specify that the `JESLOG` dataset is to be output using the `SUPPRESS` setting.

## Changing the Cataloged Procedure for Startup

You can change the contents of the standard cataloged procedure for startup according to the system environment and create a separate cataloged procedure for startup for the Mainframe Agent. The cataloged procedure (member) can have any name.

By adding the `SYSTCPD DD` statement to the cataloged procedure for startup, you can set up an environment for TCP/IP clients and programs used by the Mainframe Agent. For example, when the standard TCP stack environment is not used, you can specify the TCP/IP environment settings file by adding the `SYSTCPD DD` statement.

For details on how to specify the TCP/IP environment settings file without using the `SYSTCPD DD` statement and how to define the TCP/IP environment settings file to be specified in the `SYSTCPD DD` statement, see the explanation of a basic TCP/IP system in the *Communications Server IP Configuration Guide*.

## Setting Up the Device Manager Environment

This section describes the environment settings required for Device Manager.

### Displaying Mainframe Storage Information

The following procedure shows how to set up a Device Manager environment that enables GUI to display mainframe storage information.

### Registering the Mainframe Host in Device Manager

To use the `AddHost` command to register the mainframe host in Device Manager:

1. Execute the `AddHost` command to register the mainframe host in Device Manager.

When you execute the command, specify the following parameters:

- `hostname`: In this parameter, specify the host name of the mainframe host (the value you specified for the parameter in [Parameters on page 3-8](#)).
  - `hosttype`: In this parameter, specify 2.
2. In the result of the `AddHost` command, make sure that the specified information is correctly output to the `name` and `hosttype` parameters.

Notes on executing the `AddHost` command:



- If the host name specified during mainframe host environment setup and the host name specified during Device Manager environment setup do not match, information registered in Mainframe Agent cannot be acquired.
- Do not specify the `wnnlist` parameter when registering the mainframe host in Device Manager. If you do, an error occurs.
- Record the `objectID` value output when the `AddHost` command is executed. You will need this value for the subsequent procedures and operations.
- Although the IP address specified in the `ipaddress` parameter of a command is registered as an attribute of the mainframe host, the IP address registered using the `AddHost` command is not used for communication with Mainframe Agent. The information for communicating with Mainframe Agent is specified in [Registering the Mainframe Agent Running on the Mainframe Host on page 3-19](#).

Action to take if an error occurs during the execution of the `AddHost` command:

Use the `GetHost` command to check whether the mainframe host is registered. If the mainframe host is not registered, register it by using the `AddHost` command. If the mainframe host is registered incorrectly, use the `ModifyHost` command to correct the registered information. For details on how to correct the registered mainframe host information, see [Changing Mainframe Host Information on page 3-23](#).

Command format:

```
HiCommandCLI AddHost "hostname=mainframe-host-name" "hosttype=2"
```

Example of executing the command:

```
HiCommandCLI AddHost -o "D:\logs\AddHost.log" "hostname=toro2"
"hosttype=2"
```

## Registering the Mainframe Agent Running on the Mainframe Host

To use the `AddURLLink` command to register the mainframe host in Device Manager:

1. Execute the `AddURLLink` command to register the Mainframe Agent running on the mainframe host in Device Manager.

When you execute the command, specify the following parameters:

- `url`: In this parameter, specify the IP address and port number. If the mainframe host is in an IPv4 environment, specify the IP address of the mainframe host on which Mainframe Agent is installed, and the port number used by Mainframe Agent. `ress` (by enclosing it in square brackets (`[` and `]`)) and port number of the IBM HTTP Server.
- `name`: Specify the character string `MainframeAgent`, which indicates Mainframe Agent. This parameter is case-sensitive.

- `linkedid`: Specify the object ID of the mainframe host that was output when the mainframe host was registered using the `AddHost` command.
2. From the execution result of the `AddURLLink` command, make sure that specified information is correctly output to the `url`, `name`, and `linkedid` parameters.

Notes on executing the `AddURLLink` command:

If the `name` parameter is specified incorrectly, it will not be registered as Mainframe Agent information, resulting in mainframe storage information being inaccessible. If you specified the `name` parameter incorrectly, use the `DeleteURLLink` command to delete the Mainframe Agent information, and then use the `AddURLLink` command to register the information again. For details on how to delete the Mainframe Agent information, see [Deleting Mainframe Agent Information Registered in the Device Manager on page 3-22](#).

Action to be taken if an error occurs during the execution of the `AddURLLink` command:

Use the `GetURLLink` command to check whether Mainframe Agent is registered. If Mainframe Agent is not registered, register it by using the `AddURLLink` command. If it is registered incorrectly, use the `AddURLLink` command to correct the registered information. For details on how to correct the registered Mainframe Agent information, see [Changing Mainframe Agent Information Registered in the Device Manager on page 3-22](#).

Command format (for an IPv4 environment):

```
HiCommandCLI AddURLLink "url=http://mainframe-host-IP-address:port-
number" "name=MainframeAgent"
"linkedid=mainframe-host-object-ID"
```

Command format (for an IPv6 environment):

```
HiCommandCLI AddURLLink "url=http://IBM-HTTP-Server-IP-address#:port-
number" "name=MainframeAgent"
"linkedid=mainframe-host-object-ID"
```

# Enclose the IP address in square brackets ([ and ]).

Example of executing the command (for an IPv4 environment):

```
HiCommandCLI AddURLLink -o "D:\logs\AddURLLink.log" "url=http://
192.168.99.114:24042" "name=MainframeAgent"
"linkedid=HOST.1"
```

## Acquiring Mainframe Storage Information

Use the `AddHostRefresh` command to acquire mainframe storage information. The acquired information is not included in the command execution results. Use GUI to check this information.

When you execute the command, specify the following parameters:

`objectId`: Specify the object ID of the mainframe host that was output when the mainframe host was registered using the `AddHost` command.

Action to be taken if an error occurs during the execution of the `AddHostRefresh` command:

- a. Check whether Mainframe Agent is operating normally.  
If it is not operating normally, check the Mainframe Agent settings, and restart Mainframe Agent.
- b. Check whether the mainframe host and Mainframe Agent are registered correctly.  
If they are registered correctly, use the `AddHostRefresh` command to acquire the mainframe storage information again. If they are not registered correctly, register them correctly using the procedures described in [section Registering the Mainframe Host in Device Manager on page 3-18](#) or [Registering the Mainframe Agent Running on the Mainframe Host on page 3-19](#).

Command format:

```
HiCommandCLI AddHostRefresh "objectId=mainframe-host-object-ID"
```

Example of executing the command:

```
HiCommandCLI AddHostRefresh -o "D:\logs\AddHostRefresh.log"  
"objectId=HOST.1"
```

## Refreshing Mainframe Storage Information

To refresh the mainframe storage information displayed in GUI, use the `AddHostRefresh` command. This command is the only means of refreshing the mainframe storage information.

When you execute the command, specify the following parameter:

`objectId`: Specify the object ID of the mainframe host that was output when the mainframe host was registered using the `AddHost` command.

Action to be taken if an error occurs during the execution of the `AddHostRefresh` command:

- a. Check whether Mainframe Agent is operating normally.  
If it is not operating normally, check the Mainframe Agent settings, and restart Mainframe Agent.
- b. Check whether the mainframe host and Mainframe Agent are registered correctly.  
If they are registered correctly, use the `AddHostRefresh` command to acquire the mainframe storage information again. If they are not registered correctly, register them correctly using the procedures described in [Registering the Mainframe Host in Device Manager on](#)

page 3-18 or Registering the Mainframe Agent Running on the Mainframe Host on page 3-19.

Command format:

```
HiCommandCLI AddHostRefresh "objectid=mainframe-host-object-ID"
```

Example of executing the command:

```
HiCommandCLI AddHostRefresh -o "D:\logs\AddHostRefresh.log"  
"objectid=HOST.1"
```

## Acquiring Mainframe Agent Information Registered in the Device Manager

To acquire Mainframe Agent information registered in the Device Manager server, use the `GetURLLink` command. By executing this command, you can acquire the IP address and port number of the mainframe host from the `url` information in the execution results.

Example of executing the command:

```
HiCommandCLI GetURLLink -o "D:\logs\GetURLLink.log"  
"objectid=URLLINK.HOST.1.1"
```

## Changing Mainframe Agent Information Registered in the Device Manager

To change Mainframe Agent information registered in the Device Manager server, use the `AddURLLink` command. You can change the IP address or port number of the mainframe host by specifying a new IP address or port number in the `url` parameter in URL format.

*Note:* In the `name` parameter, specify `MainframeAgent`. If the `name` parameter is specified incorrectly, it is not registered as Mainframe Agent information, and mainframe storage information cannot be acquired. If you specified the `name` parameter incorrectly, use the `DeleteURLLink` command to delete the Mainframe Agent information, and then use the `AddURLLink` command to correct the registered Mainframe Agent information.

Example of executing the command:

```
HiCommandCLI AddURLLink -o "D:\logs\AddURLLink.log"  
"url=http://192.168.99.100:24042" "name=MainframeAgent"  
"linkedid=HOST.1"
```

## Deleting Mainframe Agent Information Registered in the Device Manager

To delete Mainframe Agent information registered in the Device Manager server, use the `DeleteURLLink` command.

*Note:* Use this command when you want to delete only Mainframe Agent registration information. For example, you may want to execute the command if you specified the `name` parameter incorrectly.

Example of executing the command:

```
HiCommandCLI DeleteURLLink -o "D:\logs\DeleteURLLink.log"  
"objectid=URLLINK.HOST.1.1"
```

## Acquiring Mainframe Host Information

To acquire information about a mainframe host registered in the Device Manager server (such as the host name), use the `GetHost` command.

*Note:* If you do not know the object ID of a mainframe host, use the following procedure to acquire the object ID.

1. Execute the `GetHost` command with no object ID specified to acquire a list of all hosts registered in Device Manager.
2. In the displayed host information, find the name of the mainframe host you are looking for.
3. Acquire the object ID based on the information related to the mainframe host you found in step 2.

Example of executing the command:

```
HiCommandCLI GetHost -o "D:\logs\GetHost.log" "objectid=HOST.1"
```

## Changing Mainframe Host Information

To change the information of a mainframe host registered in the Device Manager server, use the `ModifyHost` command. You can change the name of a mainframe host by specifying the new host name in the `hostname` parameter.

*Note:* When you change the host name, specify the host name that was set in the initialization parameter for Mainframe Agent. If you specify a host name that differs from the host name set during Mainframe Agent environment setup, you cannot acquire information from Mainframe Agent.

*Note:* The `ModifyHost` command cannot be used to modify the `hosttype` parameter information. To modify the `hosttype` parameter information, use the `DeleteHost` command to delete the target mainframe host, and then re-register the mainframe host.

Example of executing the command:

```
HiCommandCLI ModifyHost -o "D:\logs\ModifyHost.log" "objectid=HOST.  
1" "hostname=snow"
```

## Deleting a Mainframe Host

To delete a mainframe host registered in the Device Manager server, use the `DeleteHost` command.

*Note:* If you delete a mainframe host, the Mainframe Agent information registered in Device Manager is also deleted, and the mainframe storage information displayed in GUI is no longer displayed.

Example of executing the command:

```
HiCommandCLI DeleteHost -o "D:\logs\ DeleteHost.log" "objectid=HOST.1"
```

## Setting Up the Replication Manager Environment

This section describes the environment settings required for Replication Manager. For details on how to specify each setting, see the *Replication Manager User Guide*.

### Registering an Information Source

When you register Mainframe Agent as an information source, you need to specify the following information:

- Mainframe Agent name (nickname)
- IP address or host name of Mainframe Agent
- Port number

### Setting the Interval for Collecting Configuration Information

Set the interval for collecting copy pair configuration information and the start time of the collection.

### Setting the Interval for Collecting Copy Pair Status Information

Specify the interval for collecting copy pair status information, in minutes. If you do not want copy pair status information to be collected automatically, disable the setting for periodic refresh.

## Using Mainframe Agent

This chapter explains how to link with Device Manager and Replication Manager to acquire storage information that is from an open system and managed by a mainframe, and how to monitor PPRC copy pairs.

- [Using Device Manager to Collect Mainframe System Storage Information](#)
- [Using Replication Manager to Monitor PPRC Copy Pairs](#)
- [Operation Commands](#)

# Using Device Manager to Collect Mainframe System Storage Information

This section describes how to use Device Manager to collect mainframe system storage information.

## Operation Overview

When you execute information collection for Device Manager, Mainframe Agent collects storage information managed by mainframe hosts, and then provides this information to Device Manager.

The following figure provides an overview of using Device Manager to collect mainframe system storage information.

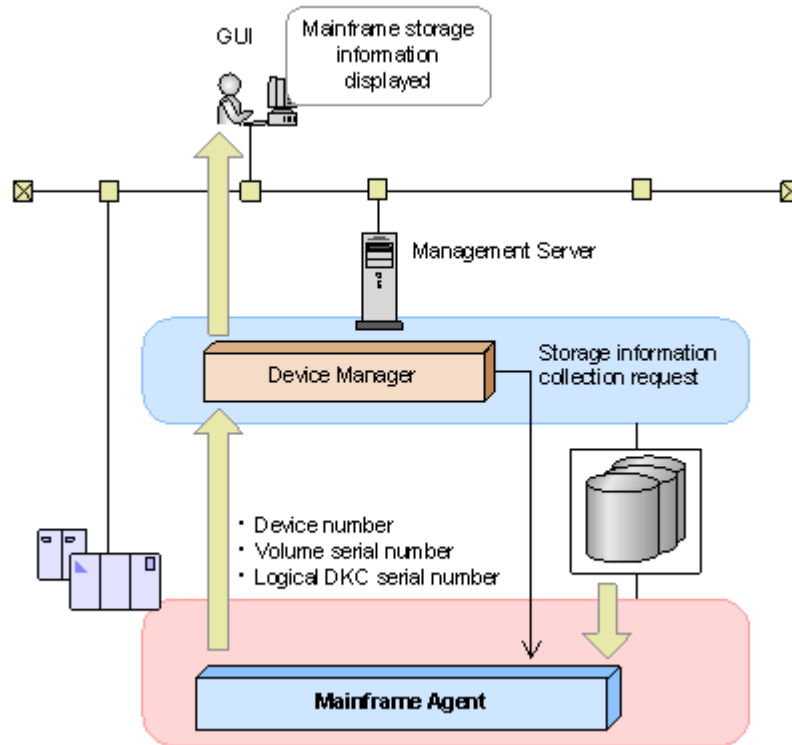
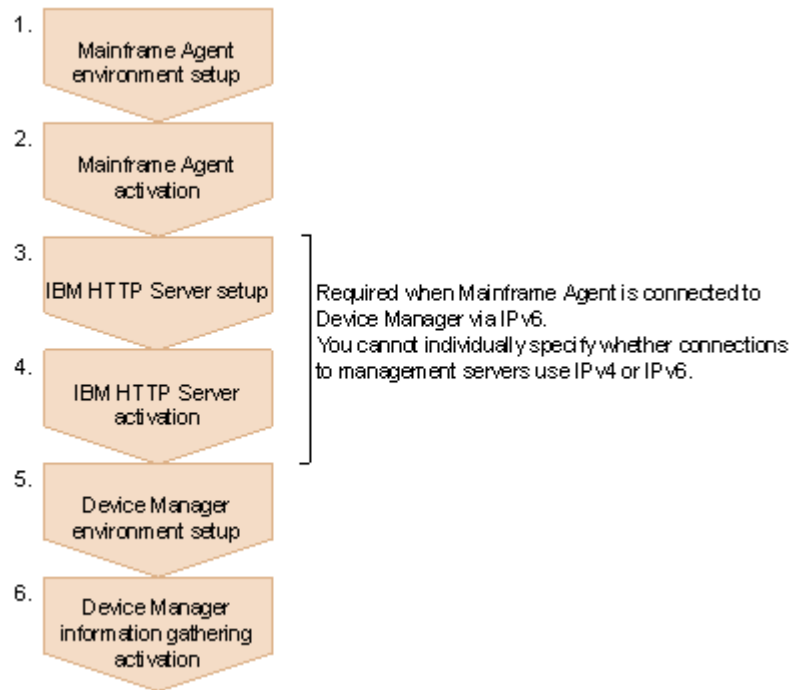

**Figure 4-1 Overview of Using Device Manager to Collect Mainframe System Storage Information**

## Operating Procedure During Installation

The following figure shows the operating procedure when installing Mainframe Agent.





**Figure 4-2 Operating Procedure for Installing Mainframe Agent**

To install Mainframe Agent:

1. See the following sections to set up the Mainframe Agent environment:
  - [Setting the TCP/IP Port Number on page 3-2](#)
  - [Setting the Security on page 3-2](#)
  - [Creating Initialization Parameters on page 3-5](#)
  - [Creating a Cataloged Procedure for Startup on page 3-16](#)
2. Start Mainframe Agent.  
see [Starting a Mainframe Agent on page 4-18](#).
3. When connecting to Device Manager by using IPv6, set up IBM HTTP Server.  
For details, [Setting Up IBM HTTP Server on page 3-4](#).
4. When connecting to Device Manager by using IPv6, start up IBM HTTP Server.
5. Set up the Device Manager environment.  
see [Setting Up the Device Manager Environment on page 3-18](#).
6. Start information collection by Device Manager.

## Operating Procedure for Changing a Configuration

The following figure shows the operating procedure when changing the configuration of Mainframe Agent.

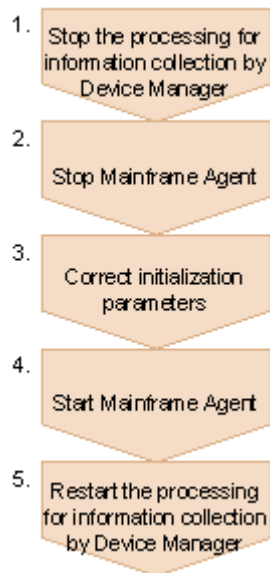

**Figure 4-3 Operating Procedure for Changing the Configuration of Mainframe Agent**

To change the configuration of Mainframe Agent:

1. Stop information collection by Device Manager.
2. Stop Mainframe Agent.  
see [Stopping a Mainframe Agent on page 4-19](#).
3. Correct the initialization parameter.  
see [Creating Initialization Parameters on page 3-5](#).
4. Start Mainframe Agent.  
see [Starting a Mainframe Agent on page 4-18](#).
5. Restart information collection by Device Manager.

## Using Replication Manager to Monitor PPRC Copy Pairs

This section describes how to use Replication Manager to monitor PPRC copy pairs.

### Operation Overview

When a request for information from Replication Manager is received, the following PPRC copy pair information is provided by Replication Manager, based on the Mainframe Agent:

- Host volume information
- Copy group definition information
- Statuses of copy pairs defined in the copy group

The following figure shows how Replication Manager monitors PPRC copy pairs.

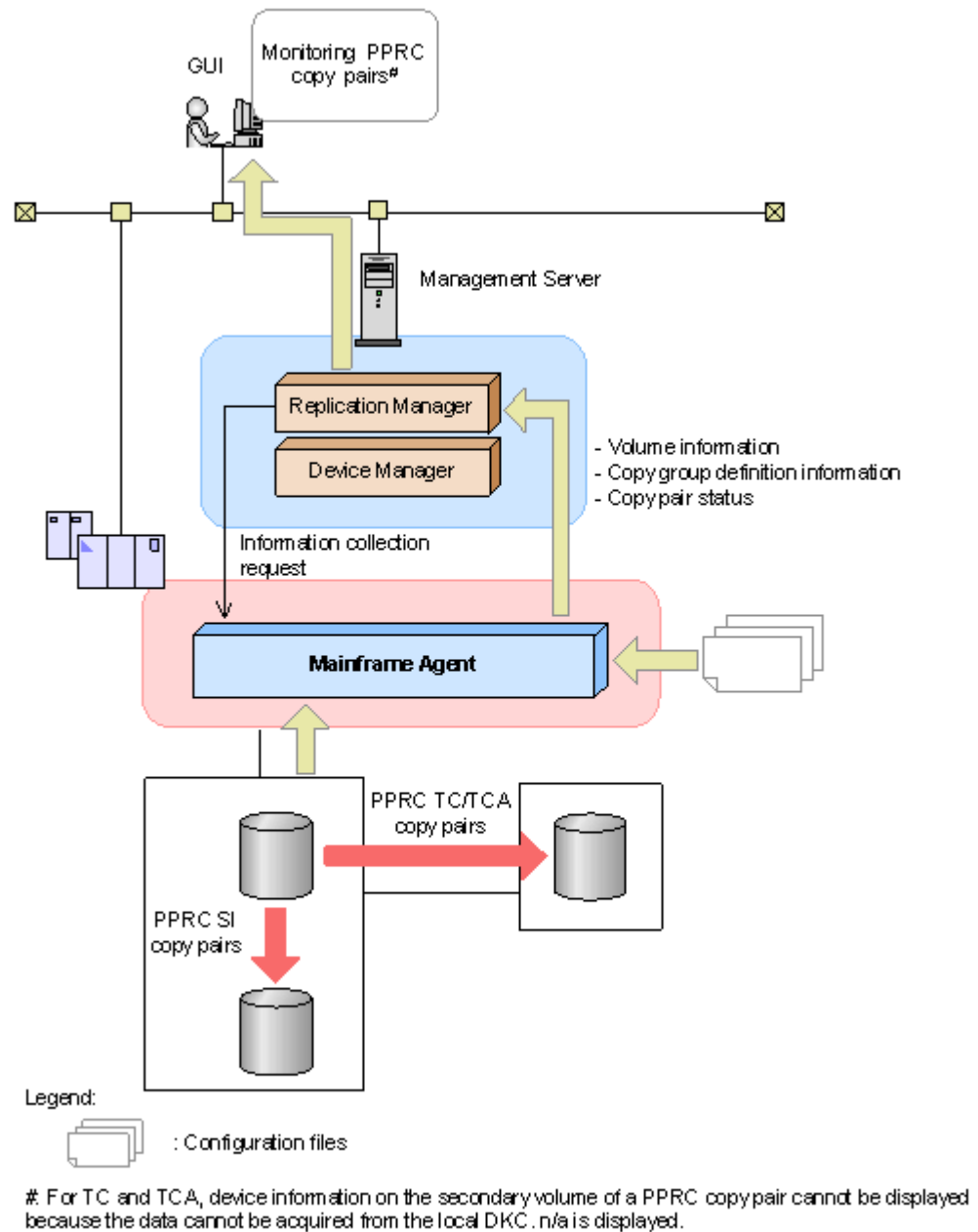

**Figure 4-4 Overview of Operation in Which Replication Manager Is Used to Monitor PPRC Copy Pairs**

**Caution:** The device number displayed as the device number of the PPRC copy pair secondary volume is not the same as the device number defined in the host because it is automatically assigned by the `YKP2A` command.

## Operation Procedures

To monitor PPRC copy pairs, configuration files for Mainframe Agent are required. The `YKP2A` command is used to create configuration files for

Mainframe Agent. The function for using the `YKP2A` command to create configuration files for Mainframe Agent is called the *copy group definition generation function for PPRC copy pairs*.

Prepare a dataset to store the configuration files below in advance. However, this step can be omitted if there is capacity available on the device or VTOC:

- Disk configuration definition file
- Copy group definition file

The following figure shows the steps to monitor PPRC copy pairs using Replication Manager:

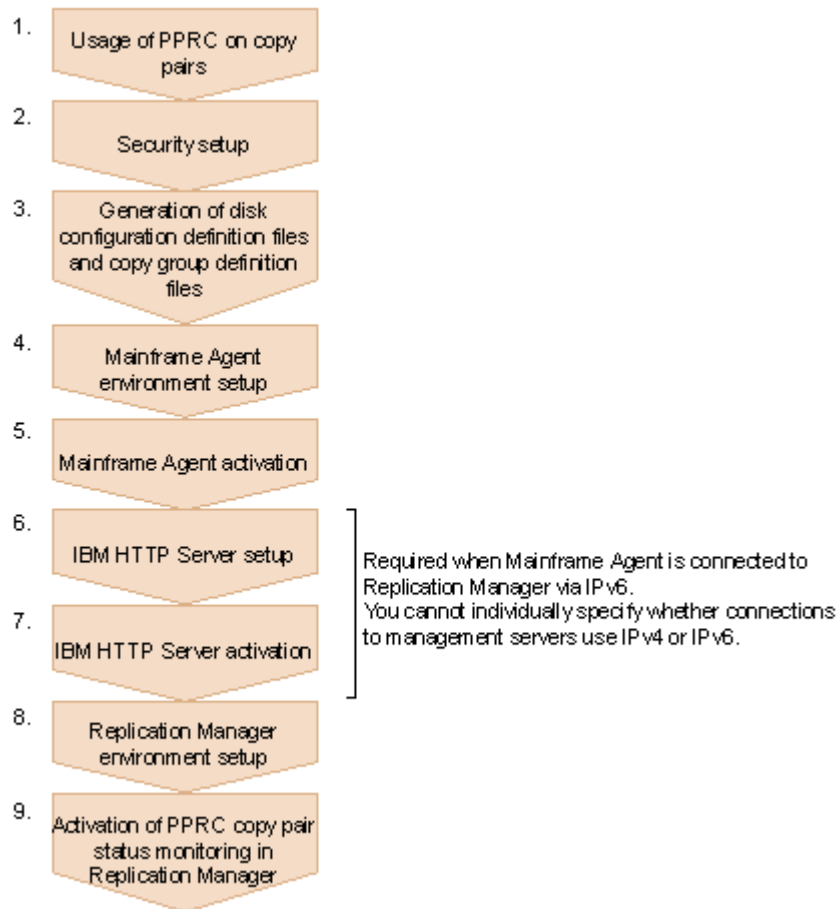

**Figure 4-5 Monitoring PPRC Copy Pairs Using Replication Manager**

1. Use PPRC to put the copy pairs in operating status.
2. Set the security.

For details, see [Setting Up the Resource Access Control Facility \(RACF\) on page 3-3](#).

3. Use the `YKP2A` command to scan for storage systems that contain primary volumes of PPRC copy pairs, and generate disk configuration files and copy group definition files.
4. See the following sections to set up the Mainframe Agent environment:

- [Setting the TCP/IP Port Number on page 3-2](#)
  - [Creating Initialization Parameters on page 3-5](#)
  - [Creating a Cataloged Procedure for Startup on page 3-16](#)
5. Start Mainframe Agent.  
see [Starting a Mainframe Agent on page 4-18](#).
  6. When connecting to Replication Manager by using IPv6, set up IBM HTTP Server.  
For details, see [Setting Up IBM HTTP Server on page 3-4](#).
  7. When connecting to Replication Manager by using IPv6, start up IBM HTTP Server.
  8. Set up the Replication Manager environment.  
see [Setting Up the Replication Manager Environment on page 3-24](#).
  9. Start monitoring PPRC copy pair statuses in Replication Manager.

## Prerequisites for the Copy Group Definition Generation Function

The following shows the prerequisites for using the copy group definition generation function for PPRC copy pairs.

### Prerequisite Hardware

The following table describes the prerequisite hardware for using the copy group definition generation function for PPRC copy pairs.

**Table 4-1 Prerequisite Hardware**

Item	Description
Host	1 machine
Storage system	Hitachi USP, Universal Storage Platform V/VM or, Virtual Storage Platform for which PPRC copy pairs are running.

### Software Settings

The following table shows the software setting items for using the copy group definition generation function for PPRC copy pairs.

**Table 4-2 Software Setting Items**

Item	Description	Notes
Copy pair	Use PPRC to change the status of ShadowImage, TrueCopy, and TrueCopy Asynchronous copy pairs to an operating status (the DUPLEX or SUSPOP status).	If the status of a PPRC copy pair is SIMPLEX, no copy group definition file is generated because the copy pair is not recognized.

## Copy Types and Units That Can Generate Configuration Files

The following table describes the copy types and units that can generate configuration files.

**Table 4-3 Copy Types and Units That Can Generate Configuration Files**

Copy type	Unit	Description
ShadowImage TrueCopy	All detected copy pairs will be defined in one configuration file.	If you want to divide a copy group up among the storage systems, divide up the specified range of device numbers of the P-VOLs in the PPRC copy pairs that will be scanned.
TrueCopy Asynchronous	One consistency group will be defined per configuration file.	This is a group based on a function provided by the storage system for preserving the consistency of volume update order. Consistency groups can be used to preserve the update order of volumes contained within them.

## Supported PPRC Commands

Table 4-4 Supported Parameter Values for the Pair Format Command (CESTPAIR) on page 4-8, Table 4-5 Supported Parameter Values for the Pair Suspend Command (CSUSPEND) on page 4-9, and Table 4-6 Supported Parameter Values for the Resynchronization Command (CESTPAIR) on page 4-9 describe the PPRC commands supported by the copy group definition generation function for PPRC copy pairs. Configuration files can be generated for PPRC copy pairs that have been defined and operated by a PPRC command with the parameter values that have Yes indicated in the *Supported* column of each of these tables.

Following is the legend associated with the tables:

- Yes: Configuration files can be generated for PPRC copy pairs that have been defined and operated by a PPRC command with this parameter value.
- No: Configuration files cannot be generated for PPRC copy pairs that have been defined and operated by a PPRC command with this parameter value.

**Table 4-4 Supported Parameter Values for the Pair Format Command (CESTPAIR)**

PPRC Copy type	Parameter	Value	Supported
ShadowImage, TrueCopy	MODE	COPY	Yes
		NOCOPY	No
	PACE	pace	No

PPRC Copy type	Parameter	Value	Supported
	CRIT	Omitted	Yes
		YES	No
	MSGREQ	NO(default)	Yes
		YES	No
TrueCopy Asynchronous	cmd_parm	AGnnX	Yes
		AVnnX	No
	MODE	COPY	Yes
		NOCOPY	No
	PACE	pace	No
		Omitted	Yes
	CRIT	YES	No
		NO(default)	Yes
MSGREQ	YES	No	
	NO(default)	Yes	

**Table 4-5 Supported Parameter Values for the Pair Suspend Command (CSUSPEND)**

PPRC Copy type	Parameter	Value	Supported
ShadowImage, TrueCopy	PRIMARY	Specified	No
		Omitted(default)	Yes
	QUIESCE	Specified	No
		Omitted(default)	Yes
TrueCopy Asynchronous	cmd_parm	AGD00	Yes
		AGP00	No
		AVD00	No
		AVP00	No

**Table 4-6 Supported Parameter Values for the Resynchronization Command (CESTPAIR)**

PPRC Copy type	Parameter	Value	Supported
ShadowImage, TrueCopy	MODE	RESYNC	Yes
	PACE	pace	No
		Omitted	Yes
	CRIT	YES	No
		NO(default)	Yes
	MSGREQ	YES	No
NO(default)		Yes	
TrueCopy Asynchronous	MODE	RESYNC	Yes

PPRC Copy type	Parameter	Value	Supported
	PACE	pace	No
		Omitted	Yes
	CRIT	YES	No
		NO(default)	Yes
	MSGREQ	YES	No
		NO(default)	Yes

## YKP2A Command

The `YKP2A` command is a TSO/E command for generating configuration files for PPRC copy pairs.

The following are explanations of the format and function of the `YKP2A` command. For details about elements and symbols used for command syntax descriptions, see [A Command Format on page A-1](#).

### Format

```
YKP2A
  ▲1PREFIX (prefix)
  ▲1DEVN (device-number-1, device-number-2)
  ▲1DAD (DADID1{, DADID2, [DADID3] } | {, , DADID3})
  [ ▲1CGNAME1 (TC-copy-group-name) ]
  [ ▲1CGNAME2 (TCA-copy-group-name) ]
  [ ▲1CGNAME3 (SI-copy-group-name) ]
```

### Function

A scan is performed within the specified primary volumes of ShadowImage, TrueCopy, and TrueCopy Asynchronous. Copy pairs that contain a secondary volume combined with one of the primary volumes detected during the scan are defined as Mainframe Agent copy groups, and configuration files (disk configuration definition file and copy group definition file) are generated. Copy group definition files are created for each copy type, along with disk configuration definition files.

Copy group definition files are created for each of the following:

- ShadowImage and TrueCopy: One per detected PPRC copy pair group
- TrueCopy Asynchronous: One per consistency group

Following are the names of the generated disk configuration definition files and copy group definition files.

Name for disk configuration definition files: *prefix.DSK.SNnnnnn.DADID*

Legend:

*nnnnn*: serial number of storage system



Name for copy group definition files: *prefix.GRP.copy-group-name*xx

Legend:

xx: 2-digit serial number starting from 00

## Parameter

**PREFIX** (*prefix*) ~ <PREFIX string consisting of 1 to 16 characters>

This specifies the prefix to be used in the names for disk configuration definition files and copy group definition files.

**DEVN** (*device-number-1, device-number-2*) ~ <4 hexadecimal characters>

This specifies the device numbers for the range over which primary volumes for PPRC copy pairs are scanned. For *device-number-1*, specify the initial **DEVN** of the scan range, and for *device-number-2*, specify the last **DEVN**. For example, to scan primary volumes of PPRC copy pairs in the device number range from 7000 to 7300, specify **DEVN(7000,7300)**. If *device-number-1* is larger than *device-number-2*, *device-number-2* is used as the initial **DEVN** in the scan range, and *device-number-1* is used as the last **DEVN**.

When the **YKP2A** command is executed, non-PPRC copy pairs are also detected. If both PPRC copy pairs and non-PPRC copy pairs exist in the same environment, specify different values for the following items so that each copy pair type is not detected at the same time.

- Range of device numbers for scanned primary volume
- Configuration file prefix

**DAD** (*DADID1*{, *DADID2*, [*DADID3*]} | {, , *DADID3*}) ~ <DAD string consisting of 1 to 28 characters>

**DAD** is a collection of volumes that can be accessed from the host. Mainframe Agent recognizes which volumes that can be accessed by the device address domain ID. To generate configuration files for PPRC copy groups, specify different device address domain IDs for primary volumes and secondary volumes.

Specify the following values for *DADID1*, *DADID2*, and *DADID3*:

- *DADID1*: Device address domain ID for the primary volumes of the PPRC TrueCopy/TrueCopy Asynchronous/ShadowImage copy pairs being scanned
- *DADID2*: Device address domain ID for the secondary volumes of the PPRC TrueCopy/TrueCopy Asynchronous copy pairs being scanned
- *DADID3*: Device address domain ID for the secondary volumes of the PPRC ShadowImage copy pairs being scanned

If *DADID3* is omitted, the configuration files for PPRC ShadowImage copy groups cannot be generated.

To generate only the configuration files for PPRC ShadowImage copy groups, specify both *DADID1* and *DADID3*, but omit *DADID2*.

The following examples show the specification of **DAD** parameters:

- To generate configuration files for PPRC TrueCopy and TrueCopy Asynchronous copy groups:  
DAD (*DADID1, DADID2*)
- To generate configuration files for PPRC TrueCopy, TrueCopy Asynchronous, and ShadowImage copy groups:  
DAD (*DADID1, DADID2, DADID3*)
- To generate configuration files for PPRC ShadowImage copy groups:  
DAD (*DADID1, , DADID3*)



**Note:** For the `PREFIX` initialization parameter, specify the same value as the value specified for *DADID1*.

`CGNAME1 (TC-copy-group-name) ~ <Copy group name string consisting of 1 to 6 characters>`

This specifies the TrueCopy copy group name. A copy group name string, which consists of one or multiple parts concatenated using periods, can be specified.

The copy group name specified by this parameter is appended with a 2-digit sequential number starting with 00, resulting in copy group names that have a maximum of 8 characters. For example, if `PREFIX (MFA.MIGRATE)` and `CGNAME1 (MFATCS)` are specified and three TrueCopy copy groups are generated, configuration files that have the following names are generated:

```
MFA.MIGRATE.GRP.MFATCS00
MFA.MIGRATE.GRP.MFATCS01
MFA.MIGRATE.GRP.MFATCS02
```

If the `CGNAME1` parameter is omitted, or no name is specified, `MYTCS` is used.

`CGNAME2 (TCA-copy-group-name) ~ <Copy group name string consisting of 1 to 6 characters>`

This specifies the TrueCopy Asynchronous copy group name. A copy group name string, which consists of one or multiple parts concatenated using periods, can be specified.

The copy group name specified by this parameter is appended with a 2-digit sequential number starting with 00, resulting in copy group names that have a maximum of 8 characters. For example, if `PREFIX (MFA.MIGRATE)` and `CGNAME2 (MFATCA)` are specified and three TrueCopy Asynchronous copy groups are generated, configuration files that have the following names are generated:

```
MFA.MIGRATE.GRP.MFATCA00
MFA.MIGRATE.GRP.MFATCA01
MFA.MIGRATE.GRP.MFATCA02
```

If the `CGNAME2` parameter is omitted, or no name is specified, `MYTCA` is used.

`CGNAME3 (SI-copy-group-name) ~ <Copy group name string consisting of 1 to 6 characters>`

This specifies the ShadowImage copy group name. A copy group name string, which consists of one or multiple parts concatenated using periods, can be specified.

The copy group name specified by this parameter is appended with a 2-digit sequential number starting with 00, resulting in copy group names that have a maximum of 8 characters. For example, if

`PREFIX` (MFA.MIGRATE) and `CGNAME3` (MFASI) are specified and three ShadowImage copy groups are generated, configuration files that have the following names are generated:

```
MFA.MIGRATE.GRP.MFASI00
MFA.MIGRATE.GRP.MFASI01
MFA.MIGRATE.GRP.MFASI02
```

If the `CGNAME3` parameter is omitted, or no name is specified, `MYSI` is used.

## Notes

- If a file with the same name as the generated disk configuration definition file and copy group definition file exists when the `YKP2A` command is executed, the file is overwritten.  
To keep the existing file, specify different names for the `PREFIX`, `CGNAME1`, `CGNAME2`, and `CGNAME3` parameters.
- When running Mainframe Agent, do not execute the `YKP2A` command. Make sure that you stop Mainframe Agent before executing the `YKP2A` command.
  - When linkage with Replication Manager is used, and the `YKP2A` command is executed, an allocation error might occur for the configuration file. In this case, stop the collection of storage information in Replication Manager, stop Mainframe Agent, and then re-execute the `YKP2A` command.
  - When the `YKP2A` command is executed, and information is requested from Replication Manager, an error might occur in Replication Manager, which prevents the collection of information. In this case, collect the information for the next request (at the set interval for Replication Manager).

## Return codes

The following table lists the return codes for when the `YKP2A` command terminates.

**Table 4-7 Return Codes for the YKP2A Command**

Return code	Description
0	Successful completion. The disk configuration definition file and copy group definition file are generated.
4	Successful completion. No PPRC copy pairs were detected in the specified device number range.

Return code	Description
8	An I/O error occurred for a volume in the scan range. Disk configuration definition files and copy group definition files have been generated for the volumes for which detection was successful.
44	Processing is canceled, due to an error. The disk configuration definition files and copy group definition files were not generated.
48	Termination was performed due to an invalid parameter.
64	An error has occurred during the REXX processing.

## Examples of Generating Configuration Files

This subsection uses the following three configuration examples to explain how configuration files are generated:

- Example configuration for monitoring PPRC TrueCopy and TrueCopy Asynchronous copy pairs
- Example configuration for monitoring only PPRC ShadowImage copy pairs
- Example configuration for monitoring PPRC TrueCopy and ShadowImage copy pairs

The `YKP2A` command is used to generate the configuration files used to monitor the copy pairs. The `YKP2A` command can be used for both batch jobs and TSO/E commands.

The conditions shown below are common to [Figure 4-6 Example Configuration for Monitoring PPRC TrueCopy and TrueCopy Asynchronous Copy Pairs on page 4-15](#), [Figure 4-7 Example Configuration for Monitoring Only PPRC ShadowImage Copy Pairs on page 4-16](#), and [Figure 4-8 Example Configuration for Monitoring PPRC TrueCopy and ShadowImage Copy Pairs on page 4-17](#). The device address domain IDs and copy group names required for use the `YKP2A` command are shown in each figure.

The following conditions are not assumed for the figures below:

- Configuration file prefix: `MFA.MIGRATE`
- Range of device numbers for scanned primary volume: from `7300` to `730F`



**Note:** The two-digit number added to the end of generated copy group definition files is a sequential number added automatically depending on the copy type.

---

### Example Configuration for Monitoring PPRC TrueCopy and TrueCopy Asynchronous Copy Pairs

The following figure shows an example of a configuration for combining PPRC TrueCopy and TrueCopy Asynchronous copy pairs.

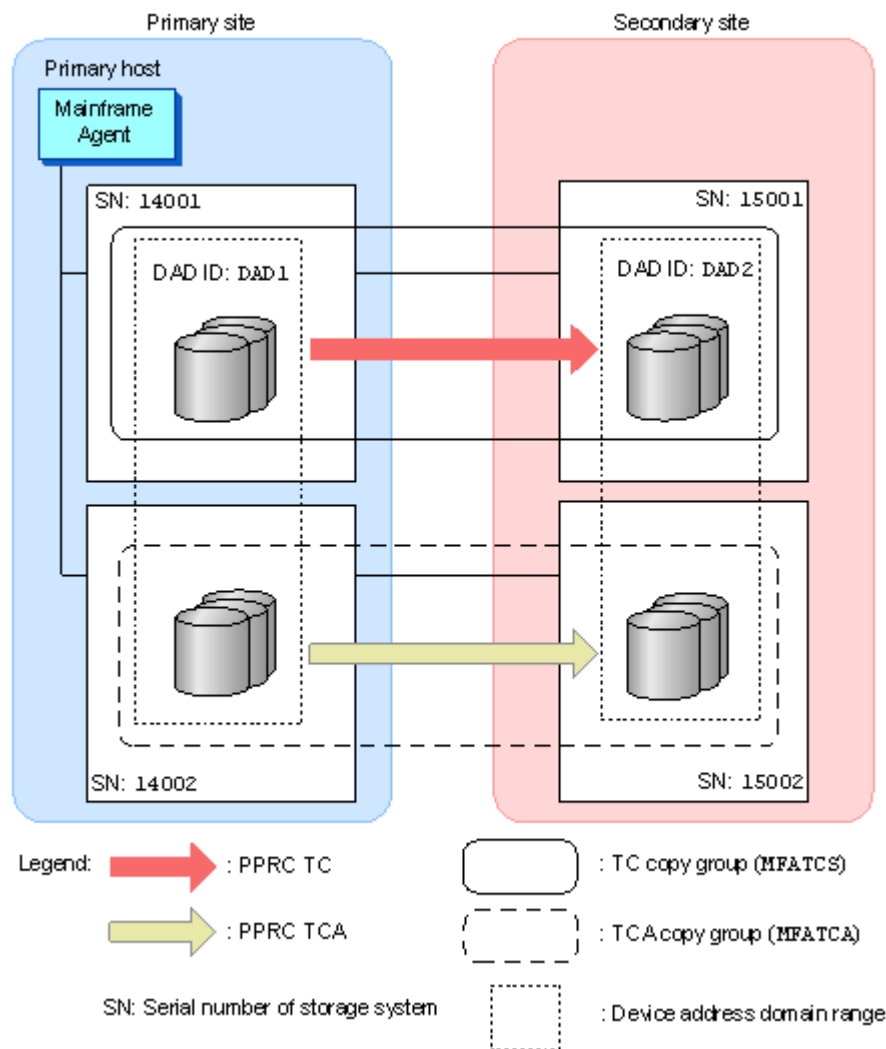

**Figure 4-6 Example Configuration for Monitoring PPRC TrueCopy and TrueCopy Asynchronous Copy Pairs**

If the following `YKP2A` command is executed in the configuration shown in [Figure 4-6 Example Configuration for Monitoring PPRC TrueCopy and TrueCopy Asynchronous Copy Pairs](#) on page 4-15, the configuration files for monitoring MFATCS and MFATCA are generated.

```
YKP2A PREFIX(MFA.MIGRATE) DEVN(7300,730F) DAD(DAD1,DAD2) CGNAME1(MFATCS)
CGNAME2(MFATCA)
```

The generated configuration files are shown below.

Disk configuration definition files:

```
MFA.MIGRATE.DSK.SN14001.DAD1
MFA.MIGRATE.DSK.SN14002.DAD1
MFA.MIGRATE.DSK.SN15001.DAD2
MFA.MIGRATE.DSK.SN15002.DAD2
```

Copy group definition files:

## Example Configuration for Monitoring Only PPRC ShadowImage Copy Pairs

The following figure shows an example of a configuration for only PPRC ShadowImage copy pairs.

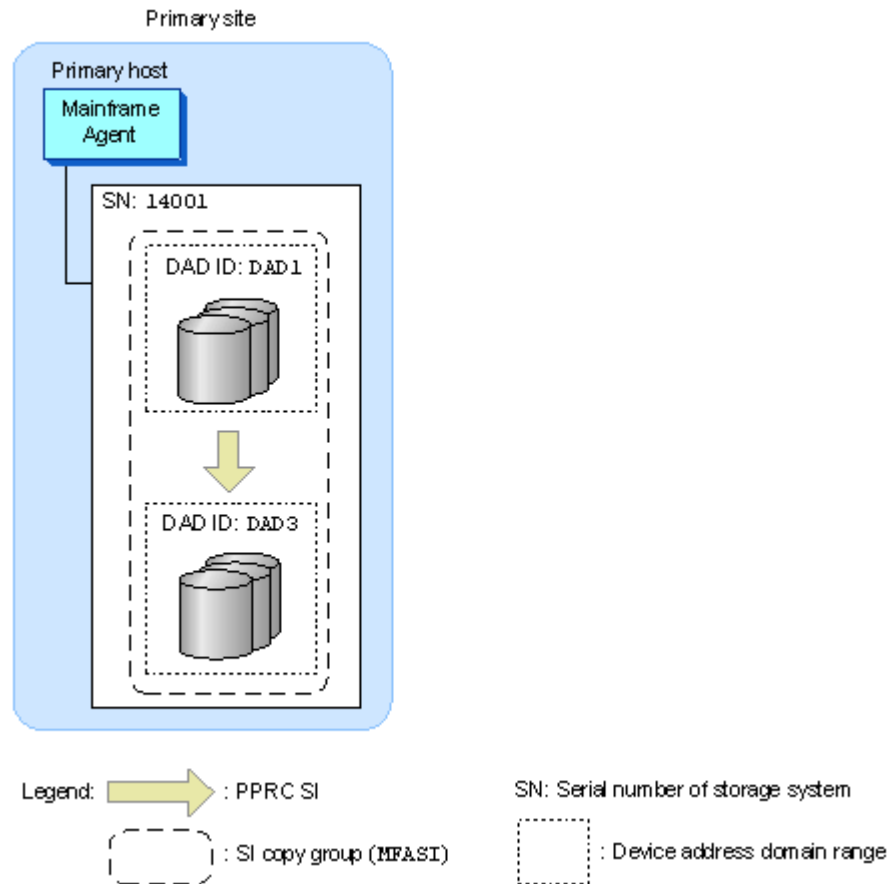

**Figure 4-7 Example Configuration for Monitoring Only PPRC ShadowImage Copy Pairs**

If the following `YKP2A` command is executed in the configuration shown in [Figure 4-7 Example Configuration for Monitoring Only PPRC ShadowImage Copy Pairs](#) on page 4-16, the configuration files for monitoring `MFASI` are generated.

```
YKP2A PREFIX (MFA.MIGRATE) DEVN (7300,730F) DAD (DAD1,,DAD3) CGNAME3 (MFASI)
```

The generated configuration files are shown below.

Disk configuration definition files:

```
MFA.MIGRATE.DSK.SN14001.DAD1
MFA.MIGRATE.DSK.SN14001.DAD3
```

Copy group definition file:

```
MFA.MIGRATE.GRP.MFASI00
```

## Example Configuration for Monitoring PPRC TrueCopy and ShadowImage Copy Pairs

The following figure shows an example of a configuration for combining PPRC TrueCopy and ShadowImage copy pairs.

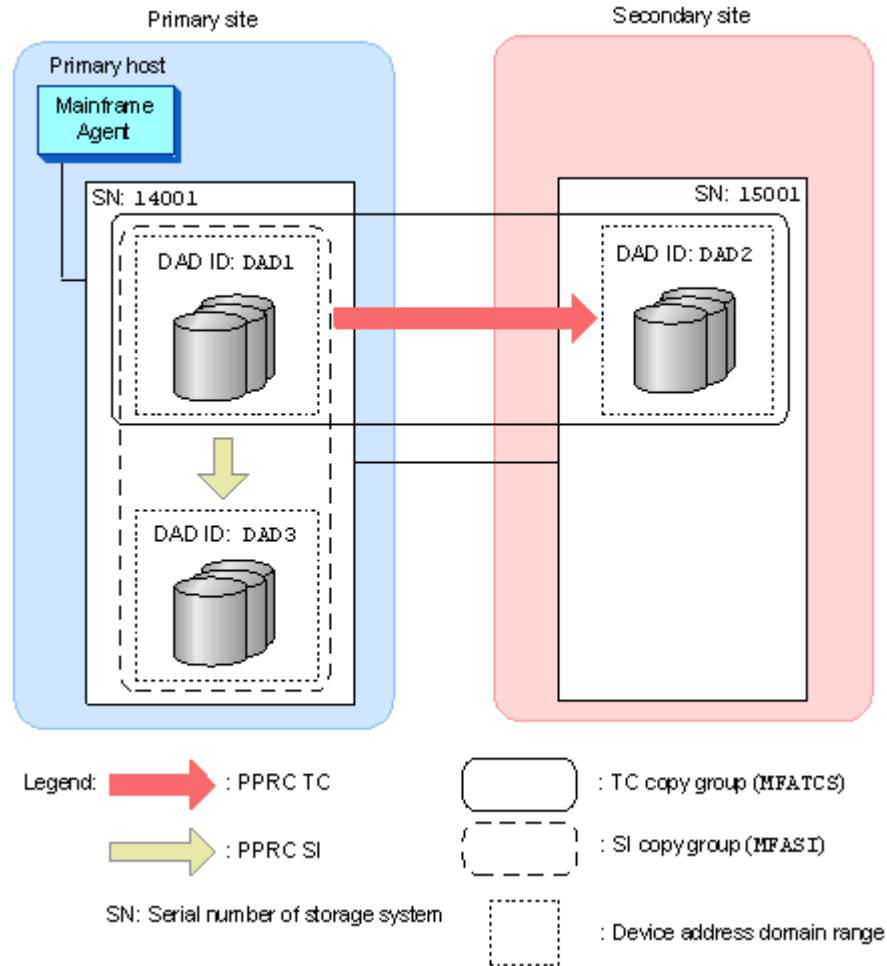

**Figure 4-8 Example Configuration for Monitoring PPRC TrueCopy and ShadowImage Copy Pairs**

If the following YKP2A command is executed in the configuration shown in [Figure 4-8 Example Configuration for Monitoring PPRC TrueCopy and ShadowImage Copy Pairs on page 4-17](#), the configuration files for monitoring MFATCS and MFASI are generated.

```
YKP2A PREFIX(MFA.MIGRATE) DEVN(7300,730F) DAD(DAD1,DAD2,DAD3) CGNAME1(MFATCS)
CGNAME3(MFASI)
```

The generated configuration files are shown below.

Disk configuration definition files:

```
MFA.MIGRATE.DSK.SN14001.DAD1
MFA.MIGRATE.DSK.SN15001.DAD2
MFA.MIGRATE.DSK.SN14001.DAD3
```

Copy group definition files:

```
MFA.MIGRATE.GRP.MFATCS00
MFA.MIGRATE.GRP.MFASIO0
```

## Operation Commands

This section describes the commands used for Mainframe Agent operation. For details on the symbols used to explain the command syntax, see [Table A-1 Symbols Used in Command Explanations on page A-2](#). For details on the command syntax elements, see [Table A-2 Command Syntax Elements on page A-2](#).

### Starting a Mainframe Agent

To start a Mainframe Agent, use the `START` command.

Mainframe Agents reside on the system, and run in accordance with the definition of the `YKPRMX` initialization parameter. You can start multiple Mainframe Agents.

Because Mainframe Agent uses the TCP/IP protocol to communicate with Hitachi Command Suite products, always start the IBM Communications Server before starting Mainframe Agent. If you do not do this, the `YKY315I` message will be displayed and Mainframe Agent will not start.

#### Format

`START`

```
△1cataloged-procedure-for-startup-name[.identification-name]
[,MEMBER=member-name]
[,SYSOUT=output-class]
```

#### Operands

*cataloged-procedure-for-startup-name*

Used to specify a name for the cataloged procedure for startup for the Mainframe Agent you are going to start.

*identification-name*

Used to specify an identification name of the cataloged procedure for startup. This operand uniquely identifies each job when the same cataloged procedure for startup name is used for multiple jobs.

MEMBER=*member-name*

Used to specify a member name of the initialization parameter. If omitted, the standard member name specified in the cataloged procedure for startup is used.

SYSOUT=*output-class*

Used to specify an output class for the output list. If omitted, the output class is automatically determined based on the system settings.



## Example

To start a Mainframe Agent with the following conditions, use one of the commands shown below:

- Name of the cataloged procedure: YKAGENTD
- Identifier: YK
- Member name of the initialization parameter: YKPRM10
- Output class: X

```
START YKAGENTD.YK, MEMBER=YKPRM10, SYSOUT=X
```

## Stopping a Mainframe Agent

To stop a Mainframe Agent, use the `STOP` command.

If a request from another Hitachi Command Suite product is accepted before execution of the `STOP` command, the stop processing is suspended until the processing for that request completes.

## Format

If both the name of the cataloged procedure for startup and the identification name were specified in the `START` command:

```
STOP  
△1[cataloged-procedure-for-startup-name.] identification-name
```

If only the name of the cataloged procedure for startup was specified in the `START` command:

```
STOP  
△1cataloged-procedure-for-startup-name
```

## Operands

*cataloged-procedure-for-startup-name*

Used to specify the name of the cataloged procedure for startup that was specified in the `START` command when a Mainframe Agent was started.

*identification-name*

Used to specify the identification name that was specified in the `START` command when a Mainframe Agent was started.

## Example

To stop a Mainframe Agent that was started and whose identification name is YK, enter the following command:

```
STOP YK
```

## Return Codes

The following table lists and describes Mainframe Agent return codes when an agent is stopped.

**Table 4-8 Return Codes When a Mainframe Agent Is Stopped**

Return Code (in decimal)	Description
0	Stopped by using the <code>STOP</code> command
4	Immediate shutdown (When the child task has terminated or abnormally terminated with a return code other than 0)
8	<ul style="list-style-type: none"><li>Initialization parameter analysis error</li><li><code>YKLIST DD</code> open error</li></ul>
12	<ul style="list-style-type: none"><li><code>GETMAIN</code> failure for the tables used by job step tasks</li><li>Other initialization errors (other than the initialization parameter analysis error)</li><li>No profile has been defined in the <code>RACF FACILITY</code> class.</li><li>Mainframe Agent has not started via <code>IKJEFT01</code></li></ul>

## Forcibly Stopping a Mainframe Agent

To forcibly stop a Mainframe Agent, use the `CANCEL` command. When this command is used, all requests are cancelled, and the Mainframe Agent is instantly stopped.

### Format

If both the name of the cataloged procedure for startup and the identification name were specified in the `START` command:

```
CANCEL
```

```
△1[cataloged-procedure-for-startup-name.] identification-name
```

If only the name of the cataloged procedure for startup was specified in the `START` command:

```
CANCEL
```

```
△1cataloged-procedure-for-startup-name
```

### Operands

*cataloged-procedure-for-startup-name*

Used to specify the name of the cataloged procedure for startup that was specified in the `START` command when a Mainframe Agent was started.

*identification-name*

Used to specify the identification name that was specified in the `START` command when a Mainframe Agent was started.

## Example

To forcibly stop a Mainframe Agent that was started and whose identification name is `YK`, enter the following command:

```
CANCEL YK
```

## Displaying the Log Output Level

To display the current Mainframe Agent log output level, use the `MODIFY` command with the `DISPLAY LOGLEVEL` parameter specified.

### Format

If both the name of the cataloged procedure for startup and the identification name were specified in the `START` command:

```
MODIFY
  ▲1[cataloged-procedure-for-startup-name.] identification-name
  ,DISPLAY LOGLEVEL
```

If only the name of the cataloged procedure for startup was specified in the `START` command:

```
MODIFY
  ▲1cataloged-procedure-for-startup-name
  ,DISPLAY LOGLEVEL
```

### Operands

*cataloged-procedure-for-startup-name*

Used to specify the name of the cataloged procedure for startup that was specified in the `START` command when a Mainframe Agent was started.

*identification-name*

Used to specify the identification name that was specified in the `START` command when a Mainframe Agent was started.

`DISPLAY LOGLEVEL`

Displays the current log output level.

## Example

To display the current log output level of a Mainframe Agent that was started and whose identification name is `YK`, enter the following command:

```
MODIFY YK,DISPLAY LOGLEVEL
YKY114I LOGLEVEL=2
```

## Changing the Log Output Level

To change the Mainframe Agent log output level, use the `MODIFY` command with the `SETINIT LOGLEVEL` parameter.

### Format

If both the name of the cataloged procedure for startup and the identification name were specified in the `START` command:

```
MODIFY
  ▲1[cataloged-procedure-for-startup-name.]identification-name
  ,SETINIT LOGLEVEL(output-level)
```

If only the name of the cataloged procedure for startup was specified in the `START` command:

```
MODIFY
  ▲1cataloged-procedure-for-startup-name
  ,SETINIT LOGLEVEL(output-level)
```

### Operands

*cataloged-procedure-for-startup-name*

Used to specify the name of the cataloged procedure for startup that was specified in the `START` command when a Mainframe Agent was started.

*identification-name*

Used to specify the identification name that was specified in the `START` command when a Mainframe Agent was started.

`SETINIT LOGLEVEL (output-level) ~ <number> ((0 to 2))`

Used to specify the new output level.

For details about the output level, see [Parameters on page 3-8](#).

### Example

To change the log output level to 2 for a Mainframe Agent that was started and whose identification name is `YK`, enter the following command:

```
MODIFY YK,SETINIT LOGLEVEL(2)
YKY111I LOGLEVEL WAS CHANGED
YKY114I LOGLEVEL=2
```

# Messages

This chapter describes the messages that are issued by Mainframe Agent.

- Message Format
- Message Output Destination
- List of Messages
- User Completion Codes

## Message Format

This section describes the format of the messages that are issued by Mainframe Agent and the notations used in this manual.

### Message Output Format

Each message issued by the Mainframe Agent consists of a message ID and the message text. The format is as follows:

*YYYnnnZ message-text*

The message ID indicates the following:

*YYY*

Indicates the program that has issued the message:

YKS: YKSTORE (an internal program of YKP2A)

YKT: YKALCSVC

YKY: Mainframe Agent, YKP2A

YKZ: All commands

*nnn*

Indicates the serial number of the message.

*Z*

Indicates the severity of the message.

E: Error

W: Warning

I: Notification of information

### Notations Used to Describe Messages

Following are the notations used to describe messages in this manual, and the message format. Messages are listed in the order of message IDs.

<i>message-ID message-output-destination</i> SC=xx <sup>#1</sup> RC=xx <sup>#2</sup> (additional- information) <sup>#3,#4</sup>	<i>message-text</i> <sup>#4</sup>	<i>description-of-the- message</i>
---	-----------------------------------	--

#1

Information returned by the message.

#2

A return code which is set when the message is output. The return code of a command contains the largest value of all return codes of messages output while the command was processing.

#3

Details identifying specific items such as error locations, or copy pair numbers.

#4

A character string enclosed in square brackets ( [ ] ) might be omitted.

## Message Output Destination

The following destinations appear in messages issued by Mainframe Agent:

- TSO: TSO/E terminal
- CON: Console
- SYS: SYSLOG
- PRT: SYSPRINT
- XML: Hitachi Command Suite product's log and window

## List of Messages

This section describes messages output by Mainframe Agent and corresponding recommended troubleshooting actions.

Message ID	Message Text	Explanation and Actions
YKS085E TSO SC=44	Error reported during file output. EXECIO RC = <i>n</i>	Because the EXECIO TSO/E REXX command failed (return code = <i>n</i> ), creation or updating of the disk configuration definition file or copy group definition file failed. For details, see the <i>TSO/E REXX User's Guide</i> .
YKS086E TSO SC=44 ( <i>file</i> )	File status is: <i>DSSTATE</i>	The input configuration file identified by <i>file</i> is unavailable. <i>DSSTATE</i> Status of the input configuration file. The following messages are output if the attribute of the input configuration file is abnormal: <ul style="list-style-type: none"> <li>• DSORG = <i>XX</i>. DSORG must be <i>YY</i> The file is unavailable because the DSORG attribute value is abnormal. Therefore, delete the current configuration file, and then create a new configuration file that has correct file attributes.</li> <li>• RECFM = <i>XX</i>. RECFM must be <i>YY</i> The file is unavailable because the RECFM attribute value is abnormal. Therefore, delete the current configuration file, and then create a new configuration file that has correct file attributes.</li> <li>• LRECL = <i>XX</i>. LRECL must be <i>YY</i> The file is unavailable because the LRECL attribute value is abnormal. Therefore, delete the current configuration file, and then create a new configuration file that has correct file attributes.</li> <li>• BLKSIZE = <i>XX</i>. BLKSIZE must be <i>YY</i></li> </ul>

Message ID	Message Text	Explanation and Actions
		<p>The file is unavailable because the <code>BLKSIZE</code> attribute value is abnormal. Therefore, delete the current configuration file, and then create a new configuration file that has correct file attributes.</p> <ul style="list-style-type: none"> <li>• <code>ALLOCATION FAILED</code> Creation of a configuration file failed. Check the free device capacity and the available size of VTOC.</li> <li>• <code>UNAVAILABLE DATASET</code> The configuration file is being used. Check the usage of the configuration file. <code>XX</code> displays the file attribute value that caused the error and <code>YY</code> displays the correct file attribute value.</li> </ul> <p><i>file</i> Name of the configuration file where the error was detected</p>
YKS099I TSO SC= <i>max-severity</i>	YKSTORE Processing Complete.	<p>YKSTORE (an internal program of YKP2A) processing has completed. This message is always displayed.</p> <p><i>max-severity</i> Maximum value among the output severity codes</p>
YKS270E TSO SC=44	Failed to <i>operation</i> configuration file. (name = <i>dataset-name</i> , <i>dsstate</i> )	<p>Creation of the configuration file is stopped because an error occurred during the creation of the configuration file. Refer to the information output in the message to review the environment, and then create the configuration file again.</p> <p><i>operation</i> The operation performed for the configuration file</p> <ul style="list-style-type: none"> <li>• <code>CREATE</code> An error occurred during the creation of the configuration file.</li> <li>• <code>UPDATE</code> An error occurred during the update of the existing configuration file.</li> </ul> <p><i>dataset-name</i> Name of the configuration file to be created</p> <p><i>dsstate</i> Status of the configuration file</p> <ul style="list-style-type: none"> <li>• <code>EXTENT=<i>extent</i></code> The number of extents of the dataset that is currently allocated <i>extent</i> indicates the number of extents that are allocated to the dataset indicated by <i>dataset-name</i>.</li> <li>• <code>DSORG=VSAM</code> The dataset format is VSAM. A dataset whose format is VSAM cannot be used as a configuration file. Change the dataset format of the configuration file into PS.</li> </ul>



Message ID	Message Text	Explanation and Actions
		<ul style="list-style-type: none"> <li>CANNOT GET DSSTATE, reason code=nnnn The dataset information cannot be obtained, or the configuration file is not assigned. nnnn (decimal (base 10) number) indicates a reason code (maintenance information).</li> </ul>
YKS298E TSO SC=44 ( <i>detailed-info</i> )	YKSTORE encountered an unexpected error.	<p>An unexpected error has occurred. This error might have occurred with another error. If another error message was output at the same time as this one, follow the instructions in that message to fix the corresponding problem. If no other error message was output, collect the following materials and contact your Hitachi Data Systems representative or authorized service provider:</p> <ul style="list-style-type: none"> <li>The script from which this command was executed</li> <li>The definition files operated on from the script (the copy group definition file, disk configuration definition file)</li> </ul> <p><i>detailed-info</i> Detailed information displayed to assist your Hitachi Data Systems representative or authorized service provider in resolving the problem</p>
YKT001E CON	Can't find SVCTABLE	The "SVCTABLE" search in the NUCLKUP macro failed. The program abnormally terminates with user completion code 996. Contact HDS Technical Support for assistance.
YKT002E CON	Can't find IGCERROR	The "IGCERROR" search in the NUCLKUP macro failed. The program abnormally terminates with user completion code 996. Contact HDS Technical Support for assistance.
YKT003E CON	No SVC #'s available	No SVC number available. The program abnormally terminates with user completion code 996.
YKT004E CON	Couldn't add SVC entry	SVC number addition failed in the SVCUPDTE macro. The program abnormally terminates with user completion code 996. Contact HDS Technical Support for assistance.
YKT005E CON	Couldn't create name/token	Name/Token registration failed. The program abnormally terminates with user completion code 996. Contact HDS Technical Support for assistance.
YKT006W CON RC=16	Couldn't delete name/token	Name/Token deletion failed. Contact HDS Technical Support for assistance.
YKT007W CON RC=16	Couldn't delete SVC entry	SVC number deletion failed in the SVCUPDTE macro. Contact HDS Technical Support for assistance.
YKT008E CON RC=20	System task started from TSO.	The YKALCSVC command was executed in the TSO/E environment. Execute the YKALCSVC command using the START command or a batch job.

Message ID	Message Text	Explanation and Actions
YKT012E CON RC=16	Name/token error	An error occurred in the Name/Token service. Contact HDS Technical Support for assistance.
YKT021E CON RC=20	Invalid parameter	A value specified in the PARM parameter is invalid. Check the specification of the PARM parameter.
YKT022E CON RC=4	SVC routine is already inserted	The user SVC routine is already registered.
YKT023E CON RC=16	Couldn't delete SVC routine	The user SVC routine deletion failed. Contact HDS Technical Support for assistance.
YKT024E CON	Couldn't copy load module	Copying of the load module failed. The program abnormally terminates with user completion code 996. Contact HDS Technical Support for assistance.
YKT025E CON RC=4	SVC routine is already deleted	The user SVC routine is not registered or is deleted.
YKT026E CON	SVC # is already used	The specified SVC number is already used. The program abnormally terminates with user completion code 996. Specify an unassigned SVC number in the PARM parameter of the YKALCSVC command, or re-execute without the PARM parameter.
YKT032E CON RC=20	The task is not APF-authorized.	The dataset name of the Mainframe Agent load library was not registered in SYS1.PARMLIB. Alternately, the execution of the command failed because authorized/unauthorized datasets co-existed while concatenating DD statements in the load library, and they were handled as unauthorized datasets.
YKT098I CON RC=0	SVC routine is deleted	The user SVC routine deletion succeeded.
YKT099I CON RC=0	SVC routine is inserted	The user SVC routine registration succeeded.
YKT299I CON SC=0	<i>command</i> command return code= <i>nnnn</i> .	The command identified by <i>command</i> terminated with the return code <i>nnnn</i> .
YKY001I CON	AGENT STARTED ( <i>vv-rr[-zz]</i> )	The Mainframe Agent has started. <i>vv</i> Version number <i>rr</i> Revision number <i>zz</i> Exception
YKY002I CON	INVALID INITIALIZATION PARAMETER: parameter-name	The specified parameter has not been defined in the initialization parameters, or the initialization parameter shown as <i>parameter-name</i> is invalid. The Mainframe Agent has been terminated. Correct the initialization parameters and then restart the Mainframe Agent.
YKY003I CON	INVALID CONTINUATION LINE FOUND. PARAMETER SCAN TERMINATED	The initialization parameters contain the specification for a continuation line, but no parameter is continued. The Mainframe Agent will be terminated.

Message ID	Message Text	Explanation and Actions
		Correct the initialization parameters and then restart the Mainframe Agent.
YKY005I CON	AGENT INITIALIZATION FAILED P=termination-code	<p>The Mainframe Agent cannot start for the reason indicated in the message that was displayed before this message. Contact the center administrator. The center administrator must take appropriate action for the message that was displayed before this message and then restart the Mainframe Agent. <i>termination-code</i> (decimal number)</p> <ul style="list-style-type: none"> <li>• 04: An attempt was made to start without using IKJEFT01.</li> <li>• 08: Initialization parameter analysis processing failed.</li> <li>• 48: A process module loading error occurred.</li> <li>• 52: A NAME/TOKEN write error occurred.</li> <li>• 56: No profile is defined in the FACILITY class of the RACF.</li> <li>• 60: Subtask initialization processing failed.</li> </ul>
YKY008I CON	INSUFFICIENT SPACE AVAILABLE FOR INITIALIZATION	<p>Initialization parameters analysis failed due to a shortage of work space. The Mainframe Agent will be terminated. Check, and, if necessary, revise the specification of the user region in the job step in the Mainframe Agent startup cataloged procedure, correct the memory requirements, and then restart the Mainframe Agent.</p>
YKY016I CON	TASK(task-ID) ABENDED, CODE=completion-code	<p>A task terminated abnormally during the Mainframe Agent start up. The Mainframe Agent will be terminated.</p> <p><i>task-ID</i> Name of the task <i>completion-code</i> System completion code</p>
YKY018I CON	MODULE( <i>load-module-name</i> ) NOT FOUND	<p>The load module shown as <i>load-module-name</i> was not found. The Mainframe Agent will be terminated. Make sure that the indicated load module was installed correctly.</p>
YKY019I CON	<i>dd-name</i> DD STATEMENT NOT FOUND	<p>The DD statement shown as <i>dd-name</i> is missing. The Mainframe Agent will be terminated. Specify the DD statement in the cataloged procedure used for starting the Mainframe Agent and then restart the Mainframe Agent.</p>
YKY020I CON	THE PROFILE IS NOT DEFINED IN THE FACILITY CLASS OF RACF: xxxxxxx	<p>The STGADMIN.YKA.BCM.YKQUERY or STGADMIN.YKA.BCM.COMMANDS profile is not defined in the FACILITY class of the RACF. Review the RACF settings and then restart the Mainframe Agent.</p> <p>xxxxxxx Maintenance information</p>

Message ID	Message Text	Explanation and Actions
YKY021I CON	A NAME/TOKEN WRITE ERROR OCCURRED,RC=return-code,NAME=name	The command cannot be executed because a NAME/TOKEN write error occurred. The Mainframe Agent will now stop. <i>return-code</i> Return code set by the NAME/TOKEN registration routine (IEANTCR) <i>name</i> Name registered in the NAME/TOKEN service
YKY022I CON	THE SPECIFIED PREFIX IS BEING USED BY ANOTHER PROGRAM	The specified prefix is being used by another program. Check the initialization parameters.
YKY051I CON	AGENT ENDED	The Mainframe Agent was terminated.
YKY052I CON	AGENT IN SCHEDULED SHUTDOWN	The Mainframe Agent termination processing has begun.
YKY053I CON	AGENT ABENDED	The Mainframe Agent terminated abnormally. If the cause is unknown, collect the ABEND dump in the SYSABEND dump format and then contact customer support for investigation.
YKY100I CON	MODIFY COMMAND ACCEPTED	The MODIFY command was accepted.
YKY101I CON	STOP COMMAND ACCEPTED	The STOP command was accepted.
YKY102I CON	INVALID error-type: text	After an entry of the MODIFY command, an error was detected in the command or operand shown as <i>text</i> . Check, and, if necessary, revise the command. <i>error-type</i> <ul style="list-style-type: none"> <li>COMMAND: Indicates that an error was detected in the command.</li> <li>OPERAND: Indicates that an error was detected in the operand.</li> </ul>
YKY103I CON	COMMAND SYNTAX ERROR	The entered command has a syntax error. Check, and, if necessary, revise the command.
YKY104I CON	OPERAND IS INCORRECT	The specified operand is invalid. Correct the error and then re-enter the operand.
YKY111I CON	<i>parameter-name</i> WAS CHANGED	The value of the initialization parameter has been changed. The parameter name is given in <i>parameter-name</i> .
YKY114I CON	parameter-name=parameter-value	This message displays the current value of the initialization parameter. <i>parameter-name</i> Initialization parameter name <i>parameter-value</i> Initialization parameter value
YKY130I CON	SESSION NO.=session-number	This message displays the TCP/IP session number. This message is followed by the TCP/IP session information. <i>session-number</i>

Message ID	Message Text	Explanation and Actions
		Session identification number
YKY131I CON	host-type PORT=port-number HOST=IP-address	This message displays the port number and IP address of the local or remote host. This message is followed by the TCP/IP session information. <i>host-type</i> <ul style="list-style-type: none"> <li>LOCAL: Indicates that the TCP/IP session information for the local host is displayed.</li> <li>REMOTE: Indicates that the TCP/IP session information for the remote host is displayed.</li> </ul> <i>port-number</i> <ul style="list-style-type: none"> <li>When LOCAL is displayed: Port number of the local host</li> <li>When REMOTE is displayed: Port number of the remote host</li> </ul> <i>IP-address</i> <ul style="list-style-type: none"> <li>When LOCAL is displayed: IP address of the local host</li> <li>When REMOTE is displayed: IP address of the remote host</li> </ul>
YKY132I CON	CONNECTING START TIME=YYYY/ MM/DD hh:mm:ss	This message displays the time the corresponding TCP/IP session was established. This message is followed by the TCP/IP session information. <i>YYYY/MM/DD hh:mm:ss</i> Time (local time)
YKY133I CON	LAST data- direction-type TIME=YYYY/MM/ DD:hh:mm:ss	This message displays the last transmission or reception time in the corresponding TCP/IP session. <i>data-direction-type</i> <ul style="list-style-type: none"> <li>SEND: Indicates the last transmission time.</li> <li>RECV: Indicates the last reception time.</li> </ul> <i>YYYY/MM/DDhh:mm:ss</i> Time (local time)
YKY300I SYS	<i>hh:mm:ss task-ID</i> , TCP CONNECTION ACCEPTED	The TCP connection request was accepted. Information about the communication with the remote host is displayed in the <i>YKY307I</i> message. <i>hh:mm:ss</i> Message output time (local time) <i>task-ID</i> Number used to identify the processing task that output the message
YKY301I SYS	<i>hh:mm:ss task-ID</i> , TCP CONNECTION ENDED NORMALLY	The TCP connection was released successfully. <i>hh:mm:ss</i> Message output time (local time) <i>task-ID</i> Number used to identify the processing task that output the message

Message ID	Message Text	Explanation and Actions
YKY304I SYS	<i>hh:mm:ss task-ID, REQUEST DENIED, REASON=(reason-for-denial)</i>	<p>The request was received, but was denied.</p> <p><i>hh:mm:ss</i> Message output time (local time)</p> <p><i>task-ID</i> Number used to identify the processing task that output the message</p> <p><i>reason-for-denial</i></p> <ul style="list-style-type: none"> <li>INVALID FORMAT: The format is invalid.</li> <li>VERSION MISMATCH: The version does not match.</li> </ul>
YKY305I CON	<i>task-ID, TCP CONNECTION LOST DURING EVENT PROCESSING, TCP-STATUS=(reason-for-disconnection)</i>	<p>The TCP connection was lost during TCP/IP processing for the reason shown as <i>reason-for-disconnection</i>.</p> <p>Determine the cause of disconnection from the remote host.</p> <p><i>task-ID</i> Number used to identify the processing task that output the message</p> <p><i>reason-for-disconnection</i></p> <ul style="list-style-type: none"> <li>FIN ACCEPT: A disconnection request (TCP-FIN) from the remote host was received.</li> <li>RST ACCEPT: A disconnection request (TCP-RST) from the remote host was received.</li> </ul>
YKY307I SYS	<i>hh:mm:ss task-ID, TCP CONNECTION INFORMATION, REMOTE-HOST=IP-address, REMOTE-PORT=remote-port-number, LOCAL-PORT=local-port-number</i>	<p>The TCP connection request was accepted. Take appropriate action according to the message that was displayed before this message.</p> <p><i>hh:mm:ss</i> Message output time (local time)</p> <p><i>task-ID</i> Number used to identify the processing task that output the message</p> <p><i>IP-address</i> IP address of the remote host</p> <p><i>remote-port-number</i> Port number of the remote host</p> <p><i>local-port-number</i> Port number of the local host</p>
YKY315I CON	<i>task-ID, COMMUNICATION ERROR, @API[, request-name[, RC=response-code]] [, EC=event-code] [, SRC=local-IP-address:local-port-number] [, DST=connection-target-IP-address:connection-target-port-number]</i>	<p>A communication error was detected. The message displays the request name, the target IP address:target port number (decimal number), and the local IP address:local port number (decimal number).</p> <p>The currently executing process is cancelled. If necessary, check the YKY330I message that was displayed immediately before this message to determine the cause of the error.</p> <p><i>task-ID</i> Number used to identify the processing task that output the message</p> <p><i>request-name</i></p> <ul style="list-style-type: none"> <li>@OPNSAP: Preprocessing</li> </ul>

Message ID	Message Text	Explanation and Actions
		<ul style="list-style-type: none"> <li>• @OPEN: Processing for establishing a connection</li> <li>• @SEND: Send processing</li> <li>• @RECV: Receive processing</li> <li>• @CLOSE: Processing for releasing the connection</li> <li>• @QUERY: Remote address search processing</li> <li>• @ABORT: Forcibly releasing the connection</li> <li>• @QUIT: Postprocessing</li> </ul> <p><i>response-code</i> Code generated during the request shown as <i>request-name</i></p> <p><i>event-code</i> Event that occurred during the TCP/IP session</p> <p><i>local-IP-address</i> IP address of the local host</p> <p><i>local-port-number</i> Port number of the local host</p> <p><i>connection-target-IP-address</i> IP address of the connection target host</p> <p><i>connection-target-port-number</i> Port number of the connection target host</p>
YKY321I CON	<i>task-ID</i> ,COMMUNICATION TIMED OUT	<p>There is no response within the specified response wait time. The connection will be released.</p> <p>Check the cause of the response timeout.</p> <p><i>task-ID</i> Number used to identify the processing task that output the message</p>
YKY330I CON	SOCKET API FAILURE ( <i>maintenance-information,request-type,return-code,error-number</i> )	<p>The request shown as <i>request-type</i> resulted in an error on the socket interface for IBM TCP/IP for MVS. <i>return-code</i> and <i>error-number</i> indicate the error information.</p> <p>Check the cause of the error and take appropriate action. If TCP/IP has stopped due to the error, stop the Mainframe Agent. Once the error is corrected, start the TCP/IP program, and then start the Mainframe Agent.</p> <p><i>maintenance-information</i> Detailed information used for error analysis</p> <p><i>request-type</i> One of the following request types is displayed:</p> <ul style="list-style-type: none"> <li>• "ACCEPT "</li> <li>• "BIND "</li> <li>• "CLOSE "</li> <li>• "INITAPI "</li> <li>• "IOCTL "</li> <li>• "LISTEN "</li> <li>• "RECV "</li> </ul>

Message ID	Message Text	Explanation and Actions
		<ul style="list-style-type: none"> <li>• "SETSOCKOPT "</li> <li>• "SOCKET "</li> </ul> <p>For details about the return code (<code>RETCODE</code>) for the request type and the error number (<code>ERRNO</code>), see the IBM manual <i>Communications Server IP API Guide</i>.</p>
YKY362I CON	RECEIVED DATA SIZE INVALID,DST=connection-target-IP-address:connection-target-port-number	<p>The Mainframe Agent received an invalid size of data from <i>connection-target-IP-address:connection-target-port-number</i>. The corresponding receive processing will be stopped.</p> <p>The size of data that can be received is 4,096 bytes. Check, and, if necessary, revise the received data size, and then re-execute the operation.</p>
YKY600I CON	INSUFFICIENT SPACE AVAILABLE. maintenance-information	<p>The area allocation by the Mainframe Agent failed. The Mainframe Agent will be terminated. Increase the region size and then restart the Mainframe Agent.</p> <p><i>maintenance-information</i> Detailed information used for error analysis</p>
YKY604I CON	IRXJCL MODULE ERROR,CODE=return-code	<p>The <code>IRXJCL</code> routine returned an error with the return code shown as <i>return-code</i>. The Mainframe Agent will terminate the processing. Check the return code. If the return code is 20, the <code>SYSEXEC DD</code> statement might be invalid in the cataloged procedure used for starting the Mainframe Agent. Check, and, if necessary, revise <code>JCL</code>, and then re-execute.</p> <p><i>return-code</i></p> <ul style="list-style-type: none"> <li>• 20: Processing failed. The <code>EXEC</code> processing was not performed.</li> <li>• 20021: The parameter list passed to <code>IRXJCL</code> was invalid.</li> </ul>
YKY605I CON	IRXINIT MODULE ERROR,CODE=return-code,R0=abnormal-termination-code-and-reason-code-for-abnormal-termination,PARM7=reason-code	<p>The <code>IRXINIT</code> routine returned an error with the return code shown as <i>return-code</i>. The Mainframe Agent will terminate the processing. Check the return code.</p> <p><i>return-code</i></p> <ul style="list-style-type: none"> <li>• 20: Processing failed due to an error. Check the reason code that was returned to <code>PARM7</code> by <code>IRXINIT</code>.</li> <li>• 100: Processing failed because the system terminated abnormally while <code>IRXINIT</code> was checking the environment. The system might output multiple messages reporting abnormal termination. <code>R0</code> includes the abnormal termination code and the reason code for abnormal termination.</li> </ul> <p><i>abnormal-termination-code-and-reason-code-for-abnormal-termination</i></p>



Message ID	Message Text	Explanation and Actions
		<p><code>IRXINIT</code> returns the abnormal termination code set in the two trailing bytes of <code>R0</code>.</p> <p><code>IRXINIT</code> returns the reason code for abnormal termination set in the two leading bytes of <code>R0</code>. If the reason code for abnormal termination is larger than two bytes, <code>IRXINIT</code> returns only the two trailing bytes of the reason code for abnormal termination. For details about the abnormal termination code and reason code, see the <i>MVS System Codes</i>.</p> <p><i>reason-code</i></p> <p>For details about the reason code, see the <i>TSO/E REXX Reference</i>.</p>
YKY606I CON	<p><code>IRXTERM MODULE ERROR, CODE=return-code, R0=abnormal-termination-code-and-reason-code-for-abnormal-termination</code></p>	<p>The <code>IRXTERM</code> routine returned an error with the indicated return code. The Mainframe Agent terminates the processing. Check the return code.</p> <p><i>return-code</i></p> <p>For details about the return code, see the <i>TSO/E REXX Reference</i>.</p> <p><i>abnormal-termination-code-and-reason-code-for-abnormal-termination</i></p> <p><code>R0</code> includes the abnormal termination code and the reason code for abnormal termination. <code>IRXTERM</code> returns the abnormal termination code set in the two trailing bytes of <code>R0</code>. <code>IRXTERM</code> returns the reason code for abnormal termination set in the two leading bytes of <code>R0</code>. If the reason code for abnormal termination is larger than two bytes, <code>IRXTERM</code> returns only the two trailing bytes of the reason code for abnormal termination. For details about the abnormal termination code and reason code, see the <i>MVS System Codes</i>.</p>
YKY680I SYS	<p><i>hh:mm:ss</i> <i>task-ID,command,</i> <i>RC=return-code[,text]</i></p>	<p>A command that was issued by the Mainframe Agent ended with <i>return-code</i>. Messages for detected errors are output to <i>text</i>. If the number of characters in the message output by the command exceeds 126, it will be displayed on multiple lines. The maximum number of message lines for a single command is 10.</p> <p><i>hh:mm:ss</i> Message output time (local time)</p> <p><i>task-ID</i> Identification number of the processing task to which the message was output</p> <p><i>command</i> Name of the command that the Mainframe Agent executed</p> <p><i>return-code</i> Return code from the command that the Mainframe Agent executed</p> <p><i>text</i></p>

Message ID	Message Text	Explanation and Actions
		Message (maintenance information) that was output by the command that the Mainframe Agent executed
YKY699I CON	AGENT FUNCTION ABEND CODE= <i>Sxxx</i> <i>Uxxxx</i> DATE= <i>yy-mm-dd</i> TIME= <i>hh:mm:nn</i> ABENDED- MODULE= <i>module-name</i> C- DATE= <i>module-creation-date</i> BASE= <i>bbbbbbbb</i> DISP= <i>dddd</i> [CALLING- MODULE= <i>module-name</i> C- DATE= <i>y'y'.m'm'.d'd</i> ' BASE= <i>bbbbbbbb</i> DISP= <i>dddd</i> ] PSW= <i>pppppppp</i> <i>pppppppp</i> ILC= <i>ll</i> INTC= <i>xx</i> REGISTERS AT TIME OF FAILURE GR 00-03 <i>contents-of-register-0</i> <i>contents-of-register-1</i> <i>contents-of-register-2</i> <i>contents-of-register-3</i> GR 04-07 <i>contents-of-register-4</i> <i>contents-of-register-5</i> <i>contents-of-register-6</i> <i>contents-of-register-7</i> GR 08-11 <i>contents-of-register-8</i> <i>contents-of-register-9</i> <i>contents-of-register-10</i> <i>contents-of-register-11</i> GR 12-15 <i>contents-of-register-12</i> <i>contents-of-register-13</i> <i>contents-of-register-14</i> <i>contents-of-register-15</i>	The main task or subtask terminated abnormally during the Mainframe Agent processing. If the task cannot be recovered, the Mainframe Agent will be terminated. Contact the center administrator. <i>Sxxx</i> (hexadecimal) System completion code when the task terminated abnormally <i>Uxxxx</i> (decimal number) User completion code when the task terminated abnormally <i>yy-mm-dd</i> Date the task terminated abnormally <i>hh:mm:dd</i> Time the task terminated abnormally <i>module-name</i> Section name of the Mainframe Agent module or the load module name. If the module cannot be identified, UNKNOWN is displayed. When UNKNOWN is displayed, the values indicated by <i>y'y'.m'm'.d'd'</i> and <i>bbbbbbbb</i> are not correct. <i>module-creation-date</i> This is displayed in one of the following formats: <i>y'y'.m'm'.d'd'</i> : Creation date of the module indicated by <i>module-name</i> <i>y'y'/m'm'/d'd'</i> : Creation date of the module indicated by <i>module-name</i> <i>bbbbbbbb</i> Contents of the base register <i>dddd</i> <ul style="list-style-type: none"> <li>• ABENDED-MODULE: Location where ABENDED-MODULE was called, relative to the top of the module</li> <li>• CALLING-MODULE: Location where CALLING-MODULE was called, relative to the top of the module</li> </ul> <i>pppppppp pppppppp</i> PSW during the abnormal termination <i>ll</i> Length of command during the abnormal termination <i>xx</i> Interrupt code during the abnormal termination

Message ID	Message Text	Explanation and Actions
YKY703E XML	XML translation error: The sent entity is not XML.	This is an XML error. The sent entity is not XML. Check, and, if necessary, revise the request coding.
YKY704E XML	End of request was detected in the comment.	The end of the XML request was detected in the comment. Check, and, if necessary, revise the comment.
YKY705E XML	End of request was detected in an element.	The end of the XML request was detected in an element. Check, and, if necessary, revise the last element in the XML request.
YKY706E XML	The number of elements exceeded the allowed limit.	The number of element hierarchies exceeded the permitted maximum value (16). Check, and, if necessary, revise the request.
YKY707E XML	The request version is a mismatch.	The API version of the XML request is not supported. Make sure that the version is supported by the Mainframe Agent.
YKY713E XML	An invalid element ' <i>element-name</i> ' was specified in the XML request.	An invalid <i>element-name</i> was specified in the XML request. Check, and, if necessary, revise the specified request. <i>element-name</i> Element name
YKY714E XML	An invalid parameter ' <i>parameter-name</i> ' was specified in the XML request element ' <i>element-name</i> '.	An invalid <i>parameter-name</i> was specified in the XML request element <i>element-name</i> . Check, and, if necessary, revise the specified request. <i>element-name</i> Element name <i>parameter-name</i> Parameter name
YKY715E XML	An invalid value was specified for the parameter ' <i>parameter-name</i> ' in the XML request element ' <i>element-name</i> '.	An invalid value was specified for <i>parameter-name</i> in the XML request element <i>element-name</i> . Check, and, if necessary, revise the specified request. <i>element-name</i> Element name <i>parameter-name</i> Parameter name
YKY716E XML	An invalid child element ' <i>child-element-name</i> ' was specified in the XML request element ' <i>parent-element-name</i> '.	An invalid child element <i>child-element-name</i> was specified for the parent element name <i>parent-element-name</i> in the XML request. If the parent element name cannot be acquired, <i>parent-element-name</i> is set to null. Check, and, if necessary, revise the specified request. <i>parent-element-name</i> Parent element name <i>child-element-name</i> Child element name
YKY717E XML	A required element is missing from the request. ' <i>element</i> '	A required element is missing in the request. Check, and, if necessary, revise the element specification in the request.

Message ID	Message Text	Explanation and Actions
		<i>element</i> Name of the missing element
YKY718E XML	A required parameter is missing from the element ' <i>element-name</i> ' of the request. ' <i>parameter-name</i> '	A required parameter is missing in the element. Check, and, if necessary, revise the corresponding element specification in the request. <i>element-name</i> Element name <i>parameter-name</i> Name of the required parameter
YKY719E XML	There is a conflict with element ' <i>element-name</i> '.	The end tag for the element shown as <i>element-name</i> does not have a paired start tag, or the correspondence between the end and start tags is invalid. Check, and, if necessary, revise the corresponding element specification in the request. <i>element-name</i> Element name
YKY720E XML	The request failed because the prefix ' <i>prefix</i> ' was not found in the Mainframe Agent initialization parameter.	The requested prefix was not found among the Mainframe Agent initialization parameters. Check and if necessary revise the specified request. <i>prefix</i> Requested prefix
YKY726E XML	Configuration file error CGname ' <i>cname</i> ' <i>error-type</i> .	The copy group definition information could not be acquired because the error indicated by <i>error-type</i> occurred in the configuration file. <i>cname</i> Copy group name <i>error-type</i> <ul style="list-style-type: none"> <li>• <b>ALLOCATE:</b> An allocation error Make sure that the copy group <i>cname</i> configuration file exists.</li> <li>• <b>EXECIO:</b> An input error Make sure that the configuration file of the copy group <i>cname</i> has not been broken.</li> <li>• <b>format:</b> An XML format error Make sure that the XML description does not contain an error.</li> <li>• <b>version:</b> A version error Make sure that the definition information version is correct.</li> </ul>
YKY901I TSO	YKP2A completed. RC=return-code	The YKP2A command terminated. <i>return-code</i> Return code of the YKP2A command
YKY902I TSO	No copy pair was discovered.	No copy pair was discovered in the specified range. Check the operating range and status of the copy pair that you want to acquire, and then execute the YKP2A command again. If the copy

Message ID	Message Text	Explanation and Actions
		pair status is Simplex, the YKP2A command does not detect any copy pair.
YKY910E TSO	Missing or invalid parameter: parameter-name	<p>A parameter specification is invalid or missing. Check the following and then execute the command again.</p> <ul style="list-style-type: none"> <li>• Make sure the required parameter indicated by <i>parameter-name</i> was specified.</li> <li>• Make sure the value specified in the required parameter indicated by <i>parameter-name</i> is valid.</li> <li>• Make sure the same DAD ID is specified for the primary storage system side and secondary storage system side of the DEVN parameter.</li> </ul> <p><i>parameter-name</i> Name of the invalid or missing parameter</p>
YKY912E TSO	Error occurred during execution. Cmd= <i>info</i> msg=message text: message value: message severity	<p>An error occurred during execution of the YKP2A command. See the explanation corresponding to the message ID of the error message indicated by <i>message-text</i> and take appropriate action. Also see the additional information indicated by <i>message-value</i> and <i>message-severity</i> and take appropriate action. If the problem is not resolved, contact maintenance personnel.</p> <p><i>info</i> Maintenance information <i>message-text</i> Error message <i>message-value</i> Additional information about the error message If no additional information is available, a space is displayed. <i>message-severity</i> Additional information about the error message If no additional information is available, a space is displayed.</p> <p>The error messages <i>message-text</i>, <i>message-value</i>, and <i>message-severity</i> are displayed in the TSO/E terminal. Depending on the length of the error messages, they might extend over several lines.</p>
YKY920W TSO	No information was acquired for DEVN=device-number	<p>No copy pair information was acquired from the volume having the device number indicated by <i>device-number</i>. There might not be a volume for the specified device number. If the volume exists, check the channel settings.</p> <p><i>device-number</i> Device number assigned to the volume from which no copy pair information was acquired</p>

Message ID	Message Text	Explanation and Actions
YKY921W TSO	No I/O paths are available for the specified devices. DEVN= <i>Devn</i>	No copy pair information was acquired from the volume to which the device number <i>Devn</i> was assigned because no I/O paths are available. Verify the I/O path settings. <i>Devn</i> Device number of the volume whose information acquisition was skipped
YKY999E TSO CON	MFAgent cannot use this REXX exec library.	A REXX script that cannot be used by Mainframe Agent was executed. Check the REXX Exec library connected to SYSEXEC dd name.
YKZ201E CON PRT SC=44	A GETMAIN error occurred. (return code= <i>nnn</i> , size= <i>mmm</i> , area= <i>area</i> , cmd= <i>xxx</i> , pos= <i>yyy</i> )	The command cannot be executed because a GETMAIN error occurred. Expand the job execution area, and then re-execute the command. <i>nnn</i> (decimal number) Return code from the GETMAIN macro <i>mmm</i> (decimal number) Area size <i>area</i> (string) HIGH must be equal to or greater than 16 MB; LOW must be less than 16 MB. <i>xxx</i> (decimal number) Command code of the command that was executing when the error occurred 0: YKLOAD, or any command (an internal program of YKP2A) 2: YKSCAN (an internal program of YKP2A) 19: YKQRYDEV (an internal program of YKP2A) <i>yyy</i> (character string) Maintenance information
YKZ206E TSO	An I/O error occurred. (detail= <i>message-text</i> , cmd= <i>xxx</i> , pos= <i>yyy</i> )	The command cannot be executed because an I/O error occurred. <i>message-text</i> (string) Message text <i>xxx</i> (decimal number) Command code of the command that was executing when the error occurred See the command code description in the explanation of the YKZ201E message. <i>yyy</i> (character string) Maintenance information
YKZ207E TSO CON SC=52	A Core process error occurred. (detail= <i>message-text</i> , cmd= <i>xxx</i> , pos= <i>yyy</i> )	The command cannot be executed because a Core processing error occurred. <i>message-text</i> (string) Message text. The message text will be as shown below: <ul style="list-style-type: none"><li>If an OS macro error occurred: XXXXXXXX macro error, return code = <i>rr</i>, devn = <i>dddd</i></li></ul>

Message ID	Message Text	Explanation and Actions
		<p>xxxxxxx: OS macro name  rr: Return code from the macro  ddd: device number</p> <ul style="list-style-type: none"> <li>• If system name acquisition failed:  ASASYMBM macro error, rc = rr  rr: Return code of ASASYMBM macro</li> <li>• If the log stream definition is not DASD-dedicated:  Not DASD-only Logger definition</li> <li>• If the MAXBUFSIZE of the log stream definition is not 64000:  MAXBUFSIZE of Logger definition invalid</li> <li>• If this message is displayed as maintenance information (1):  ENTRYID ( eeeee ) for MSGID ( nnn ) is invalid  eeee, nnn: Maintenance information</li> <li>• If this message is displayed as maintenance information (2):  ENTRYID ( eeeee ) for TYPE ( ttt ), LEVEL ( lll ) is invalid  eeee, ttt, lll: Maintenance information</li> </ul> <p>xxx (decimal number)  Command code of the command that was executing when the error occurred  See the command code description in the explanation of the YKZ201E message.</p> <p>yyy (string)  Maintenance information</p>
YKZ208I TSO PRT	The Core processing( <i>process</i> ) started. (DATE=yyyy/mm/dd, TIME=hh:mm:ss.th , TOD=ttt, cmd=xxx, pos=yyy)	The internal program processing of YKP2A is starting. <i>process</i> (string) Processing name  yyyy/mm/dd (string) GMT date  hh:mm:ss.th (string) GMT time  ttt (string) GMT time format  xxx (decimal number) Command code of the command that was executing when the error occurred See the command code description in the explanation of the YKZ201E message.  yyy (string) Maintenance information
YKZ209I TSO PRT	The Core processing( <i>process</i> ) ended. (DATE=yyyy/mm/	The internal program processing of YKP2A is terminating. <i>process</i> (string) Processing name

Message ID	Message Text	Explanation and Actions
	<i>dd</i> , TIME= <i>hh:mm:ss.th</i> , TOD= <i>ttt</i> , cmd= <i>xxx</i> , pos= <i>yyy</i> )	<i>yyyy/mm/dd</i> (string) GMT date  <i>hh:mm:ss.th</i> (string) GMT time  <i>ttt</i> (string) GMT time format  <i>xxx</i> (decimal number) Command code of the command that was executing when the error occurred See the command code description in the explanation of the YKZ201E message.  <i>yyy</i> (string) Maintenance information
YKZ211E CON SC=40	A NAME/TOKEN write error occurred. (return code= <i>nnn</i> , name= <i>name</i> , cmd= <i>xxx</i> , pos= <i>yyy</i> )	The command cannot be executed because a NAME/TOKEN write error occurred. <i>nnn</i> (decimal number) Return code set by the NAME/TOKEN registration routine (IEANTCR)  <i>name</i> (string) Name registered in the Name/Token service  <i>xxx</i> (decimal number) Command code of the command that was executing when the error occurred See the command code description in the explanation of the YKZ201E message.  <i>yyy</i> (string) Maintenance information
YKZ212W CON#	A FREEMAIN error occurred. (return code= <i>nnn</i> , cmd= <i>xxx</i> , pos= <i>yyy</i> )	A FREEMAIN error occurred. <i>nnn</i> (decimal number) Return code of the FREEMAIN macro  <i>xxx</i> (decimal number) Command code of the command that was executing when the error occurred See the command code description in the explanation of the YKZ201E message.  <i>yyy</i> (string) Maintenance information # If this message is output at a time other than when the log and trace are obtained, the YKZ212W message is not output to the console, but is recorded in LOG and TRACE. Processing will then continue.
YKZ219W CON	A LOAD error occurred. (return code= <i>nnn</i> , reason code= <i>mmm</i> , name= <i>name</i> , cmd= <i>xxx</i> , pos= <i>yyy</i> )	A LOAD macro error occurred. <i>nnn</i> (decimal number) Return code from the LOAD macro  <i>mmm</i> (decimal number) Reason code from the LOAD macro (maintenance information)



Message ID	Message Text	Explanation and Actions
		<p><i>name</i> (string) Load module name</p> <p><i>xxx</i> (decimal number) Command code of the command that was executing when the error occurred See the command code description in the explanation of the YKZ201E message.</p> <p><i>yyy</i> (string) Maintenance information</p>
YKZ250E TSO SC=40	A NAME/TOKEN delete error occurred. (return code= <i>nnn</i> , name= <i>name</i> , cmd= <i>xxx</i> , pos= <i>yyy</i> )	<p>The command cannot be executed because a NAME/TOKEN delete error occurred.</p> <p><i>nnn</i> (decimal number) Return code from the NAME/TOKEN registration routine (IEANTCR)</p> <p><i>name</i> (string) Name to be registered in the NAME/TOKEN service</p> <p><i>xxx</i> (decimal number) Command code of the command that was executing when the error occurred See the command code description in the explanation of the YKZ201E message.</p> <p><i>yyy</i> (string) Maintenance information</p>
YKZ251E TSO SC=32 ( <i>pair-index</i> )	DASD device <i>device-number-1</i> ( <i>device-number-2</i> ) management error, <i>message-text</i> . ( <i>code1 code2</i> , cmd= <i>xxx</i> , pos= <i>yyy</i> )	<p>Mainframe Agent failed to complete the requested processing. Processing will continue with this device skipped. Check the status of the error device, correct any errors related to the configuration or execution conditions, and then re-execute the command.</p> <p><i>device-number-1</i> (string) The device that issued I/O</p> <p><i>device-number-2</i> (string) The device to be manipulated If the device number of the device to be operated is not found, **** is displayed.</p> <p><i>message-text</i> (string) Message text</p> <p><i>code1</i> (Hexadecimal number) Subcommand code</p> <p><i>code2</i> (Hexadecimal number) Error code (maintenance information)</p> <p><i>xxx</i> (decimal number) Command code of the command that was executing when the error occurred See the command code description in the explanation of the YKZ201E message.</p>

Message ID	Message Text	Explanation and Actions
		<p>yyy (string) Maintenance information</p> <p><i>pair-index</i> Copy group number and copy pair number</p>
YKZ252E TSO SC=8	<p>DASD device <i>device-number-1</i>(<i>device-number-2</i>) management error, <i>message-text</i>. (<i>code1 code2</i>, cmd=<i>xxx</i>, pos=<i>yyy</i>)</p>	<p>Mainframe Agent failed to complete the requested processing. This device is skipped and processing continues. Check the status of the error device, and fix the problem in the configuration or execution condition if any.</p> <p><i>device-number-1</i> (string) The device that issued I/O</p> <p><i>device-number-2</i> (string) The device to be manipulated</p> <p><i>message-text</i> (string) Message text</p> <p><i>code1</i> (Hexadecimal number) Subcommand code</p> <p><i>code2</i> (Hexadecimal number) Error code (maintenance information)</p> <p><i>xxx</i> (decimal number) Command code of the command that was executing when the error occurred See the command code description in the explanation of the YKZ201E message.</p> <p><i>yyy</i> (string) Maintenance information</p>
YKZ253E TSO SC=32 ( <i>pair-index</i> )	<p>DASD device <i>device-number-1</i> (<i>device-number-2</i>) I/O error. (CC=<i>code1</i> CSW= <i>code2 code3 code4</i> <i>code5</i>, cmd=<i>xxx</i>, pos=<i>yyy</i>).</p>	<p>An I/O error occurred. Processing will continue with this device skipped. If a sense byte is set, the sense byte is indicated in the YKZ255E message.</p> <p>When CC=3: The corresponding device might not be configured or connected.</p> <p>When CC=0 and CSW=<i>xxxxxx0000xxxx</i> (DSB=00, CSB=00): The corresponding device might not be configured or connected.</p> <p>When CC=0 and CSW=00000000060000: MIH might have occurred or a logical path might not be connected.</p> <p><i>device-number-1</i> (string) The device that issued I/O</p> <p><i>device-number-2</i> (string) The device to be manipulated</p> <p>If the device number of the device to be operated is not found, **** is displayed.</p> <p><i>code1</i> (decimal number) CC information</p> <p><i>code2</i> (Hexadecimal number) CSW information</p> <p><i>code3</i> (Hexadecimal number) Subcommand code</p> <p><i>code4</i> (Hexadecimal number) Completion code</p> <p><i>code5</i> (Hexadecimal number)</p>

Message ID	Message Text	Explanation and Actions
		<p>Detailed code xxx (decimal number) Command code of the command that was executing when the error occurred See the command code description in the explanation of the YKZ201E message.</p> <p>yyy (string) Maintenance information</p> <p>pair-index Copy group number and copy pair number</p>
YKZ254E TSO SC=8	<p>DASD device device-number-1 (device-number-2) I/O error. (CC=code1 CSW=code2 code3 code4 code5, cmd=xxx, pos=yyy).</p>	<p>An I/O error occurred. Mainframe Agent might not support this device. Processing will continue with this device skipped. If a sense byte is set, the sense byte is indicated in the YKZ256E message.</p> <p>When CC=3: The corresponding device might not be configured or connected.</p> <p>When CC=0 and CSW=xxxxxx0000xxxx (DSB=00, CSB=00): The corresponding device might not be configured or connected.</p> <p>When CC=0 and CSW=00000000060000: MIH might have occurred or a logical path might not be connected.</p> <p>device-number-1 (string) The device that issued I/O</p> <p>device-number-2 (string) The device to be manipulated</p> <p>code1 (decimal number) CC Information</p> <p>code2 (Hexadecimal number) CSW Information</p> <p>code3 (Hexadecimal number) Subcommand code</p> <p>code4 (Hexadecimal number) Completion code</p> <p>code5 (Hexadecimal number) Detailed code</p> <p>xxx (decimal number) Command code of the command that was executing when the error occurred See the command code description in the explanation of the YKZ201E message.</p> <p>yyy (string) Maintenance information</p>
YKZ255E TSO SC=32 (pair-index)	<p>DASD device device-number-1(device-number-2) sense: diagnostic-information (cmd=xxx, pos=yyy)</p>	<p>Detailed information on the I/O error is displayed.</p> <p>device-number-1 (string) The device that issued I/O</p> <p>device-number-2 (string) The device to be manipulated</p> <p>If the device number of the device to be operated is not found, **** is displayed.</p> <p>diagnostic-information (Hexadecimal number) Sense byte information (maintenance information)</p>

Message ID	Message Text	Explanation and Actions
		<p>xxx (decimal number) Command code of the command that was executing when the error occurred See the command code description in the explanation of the YKZ201E message.</p> <p>yyy (string) Maintenance information</p> <p>pair-index Copy group number and copy pair number</p>
YKZ256E TSO SC=8	DASD device device- number-1(device- number-2) sense: diagnostic- information (cmd=xxx, pos=yyy)	<p>Detailed information on the I/O error is displayed.</p> <p>device-number-1 (string) The device that issued I/O</p> <p>device-number-2 (string) The device to be manipulated</p> <p>diagnostic-information (Hexadecimal number) Sense byte information (maintenance information)</p> <p>xxx (decimal number) Command code of the command that was executing when the error occurred See the command code description in the explanation of the YKZ201E message.</p> <p>yyy (string) Maintenance information</p>
YKZ257E TSO SC=32 (pair- index)	DASD device device- number-1(device- number-2) management error. (Message type: code1 Reason code: code2 Error code: code3 code4, cmd=xxx, pos=yyy)	<p>Mainframe Agent failed to complete the requested processing. Processing will continue with this device skipped. Check the status of the device involving the error, correct any errors related to the configuration or execution conditions, and then re-execute the command.</p> <p>device-number-1 (string) The device that issued I/O</p> <p>device-number-2 (string) The device to be manipulated If the device number of the device to be operated is not found, **** is displayed.</p> <p>code1 (Hexadecimal number) Message type</p> <p>code2 (Hexadecimal number) Reason code</p> <p>code3 (Hexadecimal number) Error code (Maintenance information)</p> <p>code4 (Hexadecimal number) Subcommand code</p> <p>xxx (decimal number) Command code of the command that was executing when the error occurred See the command code description in the explanation of the YKZ201E message.</p> <p>yyy (string) Maintenance information</p> <p>pair-index Copy group number and copy pair number</p>

Message ID	Message Text	Explanation and Actions
YKZ258E TSO SC=8	DASD device <i>device-number-1(device-number-2)</i> management error. (Message type: <i>code1</i> Reason code: <i>code2</i> Error code: <i>code3 code4</i> , cmd= <i>xxx</i> , pos= <i>yyy</i> )	Mainframe Agent failed to complete the requested processing. Mainframe Agent might not support this device. Processing will continue with this device skipped. Check the status of the device involving the error, correct any errors related to the configuration or execution conditions, and then re-execute the command. <i>device-number-1</i> (string) The device that issued I/O <i>device-number-2</i> (string) The device to be manipulated <i>code1</i> (Hexadecimal number) Message type <i>code2</i> (Hexadecimal number) Reason code <i>code3</i> (Hexadecimal number) Error code (Maintenance information) <i>code4</i> (Hexadecimal number) Subcommand code <i>xxx</i> (decimal number) Command code of the command that was executing when the error occurred See the command code description in the explanation of the YKZ201E message. <i>yyy</i> (string) Maintenance information
YKZ300E TSO SC=44 RC=44	SVC # is null or invalid.	The user SVC is not registered, or the &YKSVCNO system symbol of the IEASYMxx parmlib member is specified incorrectly. When the user SVC is defined in SVC Parm: Make sure that the &YKSVCNO system symbol of the IEASYMxx parmlib member is specified correctly. When the user SVC is not defined in SVC Parm: Register the user SVC by YKALCSVC command. For details about user SVC registration, see <a href="#">Registering a User SVC on page 2-7</a> .
YKZ301E CON RC=128	The task is not authorized to execute the request.	The task is not authorized to execute Mainframe Agent or the YKP2A command. If this message is displayed, Mainframe Agent will not send storage information to the Hitachi Command Suite products. If the YKY680I message is output to syslog after this message, the YKY680I message contains error information for the command executed by Mainframe Agent (except the YKP2A command). For details about how to grant permission to execute Mainframe Agent or the YKP2A command, see <a href="#">Setting Up the Resource Access Control Facility (RACF) on page 3-3</a> .
YKZ330E TSO RC=64	<i>command</i> detected the <i>rexx-service</i> service error.	An error was detected in the REXX service. <i>command</i> Issued CLI command name <i>rexx-service</i>

Message ID	Message Text	Explanation and Actions
	(return code= <i>r</i> [, reason code= <i>n</i> ])	Name of the REXX service where an error was detected <i>r</i> (decimal number) Return code from the REXX service For details, see the <i>TSO/E REXX User's Guide</i> . <i>n</i> (decimal number) Reason code from the REXX service For details, see the <i>TSO/E REXX User's Guide</i> .
YKZ331E TSO RC=64	<i>command</i> terminated with an invalid return code. ( <i>r</i> )	The CLI command terminated with an invalid return code. <i>command</i> Issued CLI command name <i>r</i> Return code that the CLI command created
YKZ332E TSO RC=64	<i>command</i> detected the system abend during <i>rexx-service</i> processing. (code= <i>sss</i> , reason= <i>rrrr</i> )	An abnormal system termination was detected during the REXX service processing. <i>command</i> Issued CLI command name <i>rexx-service</i> Name of the REXX service where the abnormal system termination was detected <i>sss</i> (hexadecimal number) System completion code For details, see the <i>MVS System Codes</i> . <i>rrrr</i> (hexadecimal number) Reason code
YKZ333E TSO RC=64	<i>command</i> detected the user abend during <i>rexx-service</i> processing. (code= <i>uuuu</i> , reason= <i>rrrr</i> )	An abnormal user termination was detected during the REXX service processing. <i>command</i> Issued CLI command name <i>rexx-service</i> Name of the REXX service where the abnormal user termination was detected <i>uuuu</i> (decimal number) User completion code For details, see the <i>MVS System Codes</i> . <i>rrrr</i> (hexadecimal number) Reason code
YKZ340T TSO RC=48	Supplied parameters invalid.	Invalid parameters are specified.
YKZ341E TSO RC=48	No DEVN() supplied.	Nothing is assigned to the DEVN parameter.
YKZ343E TSO RC=48	DEVN() value invalid.	The value specified in the DEVN parameter is invalid.
YKZ370E TSO SC=32 RC=32	A dynamic configuration change was detected during specified command processing. DEVN <i>device#</i>	A dynamic change in an I/O configuration definition was detected during processing of the command. Check the status of the device targeted by the command, correct any errors related to the configuration or execution conditions, and then re-execute the command. <i>device#</i>

Message ID	Message Text	Explanation and Actions
		Device number being processed when a dynamic change was detected in an I/O configuration definition

## User Completion Codes

The following table provides details about the user completion codes.

**Table 5-1 User Completion Codes**

Completion codes	Explanation
U0128	<p>The user does not have the permission to execute Mainframe Agent.</p> <p>If a reason code exists, it is displayed in the following format: <i>XXYYZZZZ</i>:</p> <p><i>XX</i>: Lower 1 byte of <i>SAF RC</i> of the <i>RACROUTE</i> macro  <i>YY</i>: Lower 1 byte of <i>RACF RC</i> of the <i>RACROUTE</i> macro  <i>ZZZZ</i>: Lower 2 bytes of <i>RACF Reason Code</i> of the <i>RACROUTE</i> macro</p> <p>Contents of the reason code:  The information returned from the <i>RACROUTE REQUEST=AUTH</i> macro is displayed. For details, see the <i>Security Server RACROUTE Macro Reference</i>.</p>
U1008	<p>An attempt was made to call a module that cannot be executed in Mainframe Agent. There might be a problem in the <i>LINKLIB</i> library settings. Specify the Mainframe Agent installation dataset for the <i>LINKLIB</i> library.</p>





# Troubleshooting

This chapter describes the troubleshooting of Mainframe Agent.

- Information Output to Logs
- When Mainframe Agent Cannot Be Started
- When Information from Mainframe Agent Is Not Updated

## Information Output to Logs

Mainframe Agent connects and exchanges storage information with Device Manager via TCP/IP.

If a communication line error or Mainframe Agent failure occurs while the Mainframe Agent is running, error information is output to the Device Manager log. However, since the error is detected after Device Manager issues a request, the output of error information might be delayed for some time after the actual error occurrence.

In addition, if an error occurs while a Mainframe Agent is attempting to acquire storage information, both the storage information and the error information will not be displayed in the Device Manager window. If this occurs, check the contents of the collected log data.

The table below shows the information that Mainframe Agents output to the logs.

**Table 6-1 Information Output to the Logs**

Trigger of the Log Output	Output Information	Output Location
Receipt of a request to establish a TCP connection	Information output in the YKY300I or YKY307I message: <ul style="list-style-type: none"> <li>• Message output time: When the connection request was received</li> <li>• Remote host's IP address</li> <li>• Remote host's port number</li> <li>• Local host's port number</li> </ul>	SYSLOG
Normal release of a TCP connection	Information output in the YKY301I message: <ul style="list-style-type: none"> <li>• Message output time: When the connection was released</li> </ul>	
Denial of a connection request	Information output in the YKY304I message: <ul style="list-style-type: none"> <li>• Message output time: When the request was denied</li> <li>• Reason for denial</li> </ul>	
Error detected during information acquisition	Information output in the YKY680I message: <ul style="list-style-type: none"> <li>• Message output time: When the command was executed</li> <li>• Command name</li> <li>• Command return code</li> </ul>	
Forced release of a TCP connection	Information output in the YKY305I message: <ul style="list-style-type: none"> <li>• Reason for release</li> </ul>	Console

Trigger of the Log Output	Output Information	Output Location
Error detected during communication processing	Information output in the <code>YKY315I</code> message: <ul style="list-style-type: none"> <li>• Name of request during TCP/IP communication</li> <li>• Response code and event code</li> <li>• Local IP address: Local port number</li> <li>• Remote IP address: Remote port number</li> </ul>	
No response after the response wait time was exceeded	The <code>YKY321I</code> message is output.	
Error detected in IBM Communications Server socket interface request	Information output in the <code>YKY330I</code> message: <ul style="list-style-type: none"> <li>• Request type</li> <li>• Return code and error number for request identification</li> </ul> See the <i>Communications Server: IP API Guide</i> .	
Size of data received is invalid	Information output in the <code>YKY362I</code> message: <ul style="list-style-type: none"> <li>• Remote IP address and remote port number</li> </ul>	
Abnormal termination of task during Mainframe Agent processing	Information output in the <code>YKY699I</code> message: <ul style="list-style-type: none"> <li>• System completion code when the task terminated abnormally</li> <li>• User completion code when the task terminated abnormally               <ul style="list-style-type: none"> <li>0007: Subtask <code>ATTACH</code> failure</li> <li>Other than 0007: Error in internal processing of Mainframe Agent</li> </ul> </li> <li>• Date and time the task terminated abnormally</li> <li>• Information on system status when the abnormal termination occurred (register contents, module information, PSW, instruction length, interrupt code)</li> </ul>	
	A memory dump is output to the location specified by the <code>SYSABEND DD</code> statement in the Mainframe Agent startup cataloged procedure JCL (normally, <code>SYSOUT=*</code> is specified).	SYSABEND dataset
The data requested by the corresponding Hitachi Command Suite products is invalid	The <code>YKY703E</code> to <code>YKY719E</code> messages are output.	A Hitachi Command Suite product window or an error log file

# When Mainframe Agent Cannot Be Started

This section describes how to troubleshoot Mainframe Agent operations.

## When a Mainframe Agent Cannot Be Started

The table below lists the events and actions to be taken when a Mainframe Agent is unable to start. In the Event column, go down in the order listed and locate the first description that matches the event that is occurring, and then use the action in the Action column to solve the problem.

**Table 6-2 Events and What To Do When a Mainframe Agent Cannot Be Started**

Event		Action
Mainframe Agent terminates with a system completion code (878).		Check and, if necessary, revise the region size of Mainframe Agent, and then restart Mainframe Agent.
The IEC130I message is displayed.		Make sure that the DD statement indicated in the message is specified correctly and then restart Mainframe Agent.
IKJEFT01 terminates with return code 12 immediately after starting.		Make sure that the STEPLIB DD statement is specified correctly and then restart Mainframe Agent.
The following message is displayed: YKY019I YKPARM DD STATEMENT NOT FOUND		Make sure that the YKPARM DD statement is defined correctly and then restart Mainframe Agent.
Mainframe Agent terminates abnormally with a system completion code (013).	The IEC141I message is displayed.	Make sure that the DD statement is defined correctly, and then restart Mainframe Agent.
	The IEC141I message is not displayed.	Take appropriate action according to the displayed message.
Mainframe Agent terminates abnormally with a system completion code (001).	The IEC020I message is displayed.	Make sure that the DD statement is defined correctly, and then restart Mainframe Agent.
	The IEC020I message is not displayed.	Take appropriate action according to the displayed message.
The following message is displayed: YKY604I IRXJCL MODULE ERROR, CODE=20	The SYSEXEC DD statement is missing.	Specify the correct SYSEXEC DD statement, and then restart Mainframe Agent.
	The SYSEXEC DD statement is displayed.	Check with the system administrator to determine if the settings for the REXX execution environment and the REXX alternate libraries environment are correct.
After being started, Mainframe Agent terminates immediately with a return code (00).		Make sure that YKAGENTD is specified in the PARM operand of the EXEC statement, and then restart Mainframe Agent.

Event	Action
An error is displayed during initialization parameter analysis.	Take appropriate action according to the displayed error message.
A TCP/IP setting error is displayed.	Take appropriate action according to the displayed message.
A message other than those above is displayed.	Take appropriate action according to the displayed message.
Mainframe Agent terminates with a return code other than (00).	Take appropriate action according to the return code.

## When Information from Mainframe Agent Is Not Updated

### When Information Obtained from a Mainframe Agent Is Not Updated

The table below lists the events and actions to be taken when information is acquired by using a Hitachi Command Suite product, but the information from a Mainframe Agent is not updated. In the Event column, go down in the order listed and locate the first description that matches the event that is occurring, and then use the action in the Action column to solve the problem.

**Table 6-3 Events and What To Do When Information from a Mainframe Agent Is Not Updated**

Event	Action
The following message is displayed: YKY330I SOCKET API FAILURE (OPEN,BIND,-0000001,0000048)	The specified port number is in use. Either terminate the program that is using the port number or change the port number in the initialization parameter, then restart Mainframe Agent.
The following message is displayed: YKY330I SOCKET API FAILURE (INIT,INITAPI,-0000001,0000156)	Protected by RACF. Check and, if necessary, revise the RACF settings, then restart Mainframe Agent.
The following message is displayed: YKY330I SOCKET API FAILURE (OPEN,BIND,-0000001,0000013)	Protected by RACF. Check and, if necessary, revise the RACF settings, then restart Mainframe Agent.
Mainframe Agent has terminated abnormally with a system completion code (Fnn). (Fnn: SVC number)	Make sure that the user SVC has been registered, then restart Mainframe Agent.
An error message is displayed on the console or in SYSLOG.	Take appropriate action according to the displayed message.





# A

## Command Format

Appendix A explains the symbols and syntax elements used in the syntax explanations of commands.

- [Symbols Used in Command Explanations](#)
- [Syntax Elements for Commands](#)

## Symbols Used in Command Explanations

The following table shows the symbols used in command explanations.

**Table A-1 Symbols Used in Command Explanations**

Font for symbol	Convention
(stroke)	Separator between multiple items, meaning "or". Example: "A B C" means "A, B, or C".
[ ]	Square brackets enclose an item whose specification is optional. When multiple items are in the square brackets, either none or one of them must be selected. Example: [A] means that either nothing or A must be specified.
Italics	Italics are used to indicate a placeholder for some actual text provided by the user or system.
<< >>	Double angle brackets enclose the default value that is assumed by the system when the corresponding item is omitted.
(( ))	Double parentheses enclose a permitted value range.
△	There is one space.
△ <sub>n</sub>	At least <i>n</i> spaces are required.
~	The item immediately preceding this symbol must observe the syntax rules in the angle brackets that follow this symbol.
< >	Angle brackets enclose the syntax rules that must be observed when each item is specified.

## Syntax Elements for Commands

The following table lists the syntax elements for commands.

**Table A-2 Command Syntax Elements**

Syntax element	Permitted character	Example
Numeric characters	0 1 2 3 4 5 6 7 8 9	--
Upper-case alphabetic characters	A B C D E F G H I J K L M N O P Q R S T U V W X Y Z _ \$ # @	--
Alphabetic characters	A B C D E F G H I J K L M N O P Q R S T U V W X Y Z a b c d e f g h i j k l m n o p q r s t u v w x y z _ \$ # @	--



Syntax element	Permitted character	Example
Alphanumeric characters	Alphabetical characters, numeric characters, or a set of alphabetic and numeric characters	A123
Hexadecimal number	0 1 2 3 4 5 6 7 8 9 A B C D E F	--
PREFIX string	A string consisting of one or more parts, joined by periods. Each part consists of upper-case alphabetical characters, or numeric characters. Note that the first character of each part must be an upper-case alphabetic character. Each part can contain from 1 to 8 characters.	ABC.D12
DAD string	A string consisting of one or more parts, joined by periods. Each part consists of upper-case alphabetical characters, numeric characters, or special characters (such as \$, #, or @). Note that the first character of each part must be an upper-case alphabetic character or special character. Each part can contain from 1 to 8 characters.	A1234.\$B
Copy group name string	A string consisting of one or more parts, joined by periods. Each part consists of upper-case alphabetical characters, numeric characters, or special characters (such as \$, #, or @). Note that the first character of each part must be an upper-case alphabetical character or special character.	@A123





# Acronyms and abbreviations

The following acronyms and abbreviations might be used in this guide.

## B

### **BLKSIZE**

block size

## D

### **DAD**

Device Address Domain

### **DASD**

Direct Access Storage Device

### **Device Manager**

Hitachi Device Manager

### **DKC**

disk controller

### **DSORG**

dataset organization

## F

### **FMID**

function modification identifier

#	A	B	C	D	E	F	G	H	I	J	K	L	M	N	O	P	Q	R	S	T	U	V	W	X	Y	Z
---	---	---	---	---	---	---	---	---	---	---	---	---	---	---	---	---	---	---	---	---	---	---	---	---	---	---

## **G**

### **GMT**

greenwich mean time

## **H**

### **Hitachi USP**

A generic term for Hitachi Universal Storage Platform and Hitachi Network Storage Controller

### **HTTP**

HyperText Transfer Protocol

## **I**

### **IBM HTTP Server**

IBM HTTP Server for z/OS

### **IPL**

initial program load

### **IPv4**

Internet Protocol Version 4

### **IPv6**

Internet Protocol Version 6

## **L**

### **LRECL**

logical record length

## **M**

### **MCS**

modification control statements

## **O**

#	A	B	C	D	E	F	G	H	I	J	K	L	M	N	O	P	Q	R	S	T	U	V	W	X	Y	Z
---	---	---	---	---	---	---	---	---	---	---	---	---	---	---	---	---	---	---	---	---	---	---	---	---	---	---

**OS**

operating system

**P****PC**

personal computer

**PPRC**

Peer to Peer Remote Copy

**R****RACF**

resource access control facility

**RECFM**

record format

**Replication Manager**

Hitachi Replication Manager

**REXX**

restructured extended executor

**S****SAF**

system authorization facility

**ShadowImage**

ShadowImage for Mainframe

**T****TCP/IP**

transmission control protocol/internet protocol

**TrueCopy**

TrueCopy for Mainframe

#	A	B	C	D	E	F	G	H	I	J	K	L	M	N	O	P	Q	R	S	T	U	V	W	X	Y	Z
---	---	---	---	---	---	---	---	---	---	---	---	---	---	---	---	---	---	---	---	---	---	---	---	---	---	---

## **TrueCopy Asynchronous**

TrueCopy for Mainframe

## **U**

### **Universal Storage Platform V/VM**

A generic term for Hitachi Universal Storage Platform V and Hitachi Universal Storage Platform VM

## **V**

### **VM**

virtual machine

### **VTOC**

volume table of contents

### **Virtual Storage Platform**

Hitachi Virtual Storage Platform

## **X**

### **XML**

extensible markup language

#	A	B	C	D	E	F	G	H	I	J	K	L	M	N	O	P	Q	R	S	T	U	V	W	X	Y	Z
---	---	---	---	---	---	---	---	---	---	---	---	---	---	---	---	---	---	---	---	---	---	---	---	---	---	---



# Glossary

Glossary defines the terms used in this manual.

## A

### **AddHost command**

A Device Manager command used for registering mainframe hosts into Device Manager.

### **AddHostRefresh command**

A Device Manager command used for refreshing mainframe storage information displayed on Device Manager GUI.

### **AddURLLink command**

A Device Manager command used for registering Mainframe Agent in Device Manager.

## C

### **CANCEL command**

An operator command used to forcibly stop a Mainframe Agent.

### **cataloged procedure for startup**

A cataloged procedure used for the startup of a Mainframe Agent.

### **configuration file**

A generic name that refers to copy group definition files, and disk configuration definition files.

### **consistency group**

A group that preserves consistency in the update sequence when volumes in the group are updated.

#	A	B	C	D	E	F	G	H	I	J	K	L	M	N	O	P	Q	R	S	T	U	V	W	X	Y	Z
---	---	---	---	---	---	---	---	---	---	---	---	---	---	---	---	---	---	---	---	---	---	---	---	---	---	---

**copy group**

A group of several pair volumes that the user uses for the same operation.

**copy pair status**

The status of a P-VOL and S-VOL copy pair.

Example: SIMPLEX, DUPLEX, SUSPOP, PENDING

**D****DeleteHost command**

A Device Manager command used for deleting mainframe hosts registered in Device Manager.

**DeleteURLLink command**

A Device Manager command used for deleting Mainframe Agent registration information registered in Device Manager.

**Device Address Domain**

Indicates sites that adopt the same device numbering system. If several hosts on the same site have the same device numbering system, they have the same name.

**Device Address Domain ID**

An ID that Mainframe Agent uses to identify DADs.

**Device Manager**

The base program for storage management. Device Manager can integrate storage operations and management functions.

**DEVN**

A device number used by a mainframe host to manage storage volumes.

**G****GetURLLink command**

A Device Manager command used for acquiring Mainframe Agent registration information registered in Device Manager.

**H****Hitachi Business Continuity Manager**

A program used for building a highly reliable backup system in which multiple data centers are linked together. In the event of a disaster, this program enables operations

#	A	B	C	D	E	F	G	H	I	J	K	L	M	N	O	P	Q	R	S	T	U	V	W	X	Y	Z
---	---	---	---	---	---	---	---	---	---	---	---	---	---	---	---	---	---	---	---	---	---	---	---	---	---	---



to continue by using the copy functions of the storage systems, and also enables you to minimize the restoration time or data loss from a disaster.

### **Hitachi Command Suite products**

A group of programs that support the creation, operation, and monitoring of storage systems.

### **host identification name**

A name specified to identify a mainframe when the volume information for multiple mainframe hosts is obtained. This name is specified by using the initialization parameter `HOSTNAME` of the Mainframe Agent.

## **I**

### **initialization parameter**

A parameter used for setting up the environment of the Mainframe Agent at the startup of the agent. The following settings are available by using this parameter: the port number, reception wait time, host identification name, information about the PPRC copy group monitoring status (the prefix for configuration files, and the device address domain ID for the primary site), range of device numbers for information collection, and the log output level.

## **J**

### **JES startup procedure**

A cataloged procedure to start JES (Job Entry Subsystem).

## **L**

### **log level**

A level that controls the output of the following types of messages: messages, which are output to the system log (SYSLOG) while the Mainframe Agent is running, that show the progress of the communication execution, and error messages that are output when storage information is collected. This log level is specified by using the initialization parameter `LOGLEVEL` of the Mainframe Agent.

## **M**

### **ModifyHost command**

A Device Manager command used for changing mainframe host information registered in Device Manager.

#	A	B	C	D	E	F	G	H	I	J	K	L	M	N	O	P	Q	R	S	T	U	V	W	X	Y	Z
---	---	---	---	---	---	---	---	---	---	---	---	---	---	---	---	---	---	---	---	---	---	---	---	---	---	---

## P

### PPRC

An IBM backup product that executes synchronous copying without passing through the host.

### primary site

A generic term for a primary host or a primary storage system, or a site where they are located. This site normally runs applications and is the source for backup copies.

## R

### RACF

An IBM security management product.

### REXX

A type of structured programming language developed by IBM. Mainly employed by IBM's mainframe OS, REXX is used as the macro language for calling application and OS functions.

### REXX alternate library

An alternate library used when neither of the following libraries exists: IBM Library for REXX on zSeries Release 4 (FMID HWJ9140), or IBM Library for REXX on zSeries Alternate Library (FMID HWJ9143).

## S

### secondary site

A site with a recovery host and a storage system in a 2DC configuration. This is the destination for backup copies. To prevent both hosts from stopping simultaneously during a disaster, it should be some hundreds to some thousands of kilometers away from the primary host.

### serial number of storage system

In Lightning 9900V series and Hitachi USP, a serial number of storage system is a number assigned to each storage system (physical DKC serial number). In Universal Storage Platform V/VM and Virtual Storage Platform, a serial number of storage system is a number assigned to each logical disk controller (logical DKC serial number)

### SETINIT command

A command used to set the initialization parameter for the Mainframe Agent. By specifying this parameter in the `MODIFY` command, you can dynamically change the log output level.

#	A	B	C	D	E	F	G	H	I	J	K	L	M	N	O	P	Q	R	S	T	U	V	W	X	Y	Z
---	---	---	---	---	---	---	---	---	---	---	---	---	---	---	---	---	---	---	---	---	---	---	---	---	---	---

**ShadowImage**

A function for replicating and maintaining replications of volumes in the storage system.

**START command**

An operator command used to start a Mainframe Agent.

**STOP command**

An operator command used to stop a Mainframe Agent.

**suspend status**

A collective name for the SUSPOP status, SUSPCU status and, SUSPER status.

**T****TrueCopy**

A function that creates and manages remote copies of volumes between storage systems. This writes a copy pair to the S-VOL synchronously with the P-VOL.

**TrueCopy Asynchronous**

A function that creates and manages remote copies of volumes between storage systems. This writes a copy pair to the S-VOL asynchronously with the P-VOL.

**V****VOLSER**

A volume serial number used by a mainframe host to manage storage volumes.

**Y****YKAGALLO job**

A job that assigns datasets required before installation of the Mainframe Agent.

**YKAGENTD**

An executable program of the Mainframe Agent. This is also the name of the standard startup cataloged procedure of the Mainframe Agent.

**YKAGINST job**

A job that installs Mainframe Agent.

**YKALCSVC command**

A command used for registering the user SVC required for running Mainframe Agent. This command is started by the OS `START` command.

#	A	B	C	D	E	F	G	H	I	J	K	L	M	N	O	P	Q	R	S	T	U	V	W	X	Y	Z
---	---	---	---	---	---	---	---	---	---	---	---	---	---	---	---	---	---	---	---	---	---	---	---	---	---	---

**YKP2A command**

A command used to generate configuration files, which are used to monitor PPRC copy pairs.

**YKPRM00**

A member to which an initialization parameter (required to run the the Mainframe Agent) is registered.

#	A	B	C	D	E	F	G	H	I	J	K	L	M	N	O	P	Q	R	S	T	U	V	W	X	Y	Z
---	---	---	---	---	---	---	---	---	---	---	---	---	---	---	---	---	---	---	---	---	---	---	---	---	---	---

# Index

## A

- acquiring
  - Mainframe Agent information (Device Manager) 3-22
  - mainframe host information (Device Manager) 3-23
  - mainframe storage information (Device Manager) 3-20
- AddHost command Glossary-1
  - notes on executing 3-18
- AddHostRefresh command Glossary-1
- AddURLLink command Glossary-1
  - notes on executing 3-20

## C

- CANCEL command
  - format 4-20
  - glossary Glossary-1
- cataloged procedure for startup Glossary-1
  - changing 3-18
- cataloged procedure library
  - removing concatenation 2-11
- changing
  - cataloged procedure for startup 3-18
  - log output level 4-22
  - Mainframe Agent information (Device Manager) 3-22
  - mainframe host information (Device Manager) 3-23
- checking
  - before upgrading 2-10
  - whether to upgrade Device Manager 2-10

- checks
  - pre-installation 2-2
- collecting trace log 3-5
- command syntax elements A-2
- commands
  - operation commands 4-18
- configuration example
  - connecting to Device Manager 3-13
  - connecting to Replication Manager 3-14
  - establishing connections by using IPv6 3-4
- configuration file Glossary-1
  - copy types and units 4-8
  - generation 4-14
- connecting via IPv6
  - configuration example 3-4
- consistency group Glossary-1
- convention for Storage Capacity Values
  - KB, MB, GB and TB xi
- copy group Glossary-2
- copy pair status Glossary-2
- creating
  - initialization parameter 3-5
- Creating a Cataloged Procedure for Startup 3-16

## D

- datasets
  - provided 2-2
- datasets, backing up 2-10
- DELETE parameter
  - YKALCSVC command 2-7
- DeleteHost command Glossary-2
- DeleteURLLink command Glossary-2
- deleting

- Mainframe Agent information (Device Manager) 3-22
- mainframe host (Device Manager) 3-24
- user SVC 2-10

- Device Address Domain Glossary-2
- Device Address Domain ID Glossary-2
- Device Manager Glossary-2
  - collecting mainframe system storage information 4-2
  - when connecting 3-12

- DEVN
  - format 3-11
  - glossary Glossary-2

- directive
  - CacheDisable 3-5
  - KeepAlive 3-5
  - Listen 3-5
  - LoadModule 3-5
  - ProxyPass 3-5
  - ProxyPassReverse 3-5
  - Timeout 3-5

- displaying
  - log output level 4-21

## E

- EXEC statement 3-16

## F

- format
  - YKALCSVC command 2-7

## G

- GB meaning xi
- generating configuration files
  - copy types and units 4-8
- GetURLLink command Glossary-2
- glossary Glossary-1

## H

- Hitachi Business Continuity Manager Glossary-2
- Hitachi Command Suite products Glossary-3
- host identification name 3-9
  - glossary Glossary-3

- HOSTNAME 3-9
  - how to use
    - SETINIT command 3-6
- httpd.conf
  - settings to be specified for IPv6 connection 3-5

## I

- IEASVCxx paramlib member, using to register user SVC 2-8
- information output to logs 6-2
- initialization parameter Glossary-3
  - creating 3-5
- initialization parameters
  - specification examples 3-12
- installation overview 2-2
- installing
  - Mainframe Agent 2-1
  - procedure 2-4
  - REXX alternate library 2-6

## J

- JES startup procedure 3-16
- JES startup procedure (glossary) Glossary-3

## K

- KB meaning xi

## L

- library datasets
  - storage attributes 2-3
- load library
  - removing concatenation 2-11
- log level Glossary-3
- log output level
  - changing 4-22
  - displaying 4-21
- LOGLEVEL parameter 3-11
- logs
  - output information 6-2

## M

- Mainframe Agent

- checking settings after upgrading 2-11
- installing 2-1
- operating procedure for changing the configuration 4-4
- operating procedure for installing 4-3
- overview 1-1
- purpose of installing 1-2
- registering 3-19
- setting up 3-1
- starting 4-18
- upgrading 2-9, 2-11
- using 4-1
- Mainframe Agent information (Device Manager)
  - acquiring 3-22
  - changing 3-22
  - deleting 3-22
- mainframe host
  - registering, in Device Manager 3-18
- mainframe host (Device Manager)
  - deleting 3-24
- mainframe host information (Device Manager)
  - acquiring 3-23
  - changing 3-23
- mainframe storage information (Device Manager)
  - acquiring 3-20
  - refreshing 3-21
- MB meaning xi
- memory requirements 2-4
- ModifyHost command Glossary-3
- monitoring
  - PPRC ShadowImage copy pair (configuration example) 4-16
  - PPRC TrueCopy and ShadowImage copy pairs (configuration example) 4-17
  - PPRC TrueCopy and TrueCopy Asynchronous copy pairs (configuration example) 4-14

## N

- note
  - specifying DEVN parameter 3-11
  - specifying HOSTNAME parameter 3-9
  - specifying PREFIX parameter 3-10
- notes
  - upgrading 2-9
- notes on
  - executing the AddHost command 3-18
  - executing the AddURLLink command 3-20

## O

- operating procedure
  - during installation 4-2
  - for changing configuration 4-3
- operation commands 4-18
- output information
  - to logs 6-2
- overview
  - using Device Manager to collect mainframe system storage information 4-2

## P

- parameters
  - determining whether parameters can be specified more than once 3-11
- PORT parameter 3-8
- PPRC Glossary-4
- PPRC ShadowImage copy pairs
  - configuration example for monitoring 4-16
- PPRC TrueCopy and ShadowImage copy pairs
  - configuration example for monitoring 4-17
- PPRC TrueCopy and TrueCopy Asynchronous copy pairs
  - configuration example for monitoring 4-14
- pre-installation
  - checks 2-2
- pre-upgrade procedure 2-10
- PREFIX 3-9
- prerequisite equipment 1-3
- prerequisite hardware 4-7
- Prerequisites for the Copy Group Definition Generation Function 4-7
- primary site Glossary-4
- PROC statement 3-16
- PROFILE.TCPIP profile 3-2
- provided datasets 2-2

## R

- RACF Glossary-4
- RECVWAITTIME parameter 3-9
- refreshing
  - mainframe storage information (Device Manager) 3-21
- registering
  - Mainframe Agent in Device Manager 3-19

- mainframe host in Device Manager 3-18
- Replication Manager
  - monitoring PPRC copy pairs 4-4
  - monitoring PPRC copy pairs operation overview 4-5
  - when connecting 3-14
- requirements
  - application software 1-2
  - installation 1-2
  - operating system 1-2
- REXX Glossary-4
- REXX alternate library Glossary-4
  - installation 2-6

## S

- secondary site Glossary-4
- security, setting
  - dataset security 3-2
- serial number of storage system Glossary-4
- SETINIT command
  - format 3-6
  - glossary Glossary-4
  - how to use 3-6
- setting
  - TCP/IP port number 3-2
- setting the security 3-2
- setting up
  - Device Manager 3-18
  - Mainframe Agent 3-1
  - Replication Manager 3-24
- setting up IBM HTTP Server 3-4
- setting up the Resource Access Control Facility (RACF) 3-3
- settings for connecting via IPv6 (IBM HTTP Server) 3-4
- settings for using
  - YKALCSVC command 2-6
  - YKP2A command 2-9
- software settings 4-7
- standard cataloged procedure for startup 3-16
- standard cataloged procedure for startup in the expanded format 3-16
- START command
  - format 4-18
  - glossary Glossary-5
- STEPLIB DD statement 3-17
- STOP command

- format 4-19
- glossary Glossary-5
- storage attributes
  - library datasets 2-3
- supported PPRC commands 4-8
- suspend status Glossary-5
- SVC-number parameter
  - YKALCSVC command 2-7
- symbols used in command explanations A-2
- SYSABEND DD statement 3-17
- SYSEXEC DD statement 3-17
- system configuration example 1-3
- SYSTSIN DD statement 3-17
- SYSTSPRT DD statement 3-17

## T

- TB meaning xi
- troubleshooting 6-1
  - when information from Mainframe Agent is not updated 6-5
  - when Mainframe Agent cannot be started 6-4

## U

- upgrade Device Manager
  - checking whether to 2-10
- upgrading
  - checking before upgrading 2-10
  - deleting user SVC 2-10
  - Mainframe Agent 2-11
  - notes 2-9
  - removing concatenation of cataloged procedure libraries 2-11
  - removing concatenation of load libraries 2-11
- user SVC
  - deleting 2-10
  - registering 2-7
- user SVC number
  - checking 2-10
- using
  - Device Manager to collect mainframe system storage information 4-2

## V

- VOLSER Glossary-5



## W

when connecting

Device Manager 3-12

Replication Manager 3-14

## Y

YKAGALLO job Glossary-5

YKAGENTD

expanded format 3-16

glossary Glossary-5

YKAGINST job Glossary-5

YKALCSVC command Glossary-5

DELETE parameter 2-7

format 2-7

settings for using 2-6

SVC-number parameter 2-7

to register user SVC 2-8

YKALCSVC command format 2-7

YKLIST DDstatement 3-17

YKP2A command 4-10

CGNAME1 4-12

CGNAME2 4-12

CGNAME3 4-12

DAD 4-11

DEVN 4-11

glossary Glossary-6

PREFIX 4-11

settings for using 2-9

YKPARAM DD statement 3-17

YKPRM00 Glossary-6





Hitachi Data Systems

**Corporate Headquarters**

750 Central Expressway  
Santa Clara, California 95050-2627  
U.S.A.  
Phone: 1 408 970 1000  
[www.hds.com](http://www.hds.com)  
[info@hds.com](mailto:info@hds.com)

**Asia Pacific and Americas**

750 Central Expressway  
Santa Clara, California 95050-2627  
U.S.A.  
Phone: 1 408 970 1000  
[info@hds.com](mailto:info@hds.com)

**Europe Headquarters**

Sefton Park  
Stoke Poges  
Buckinghamshire SL2 4HD  
United Kingdom  
Phone: + 44 (0)1753 618000  
[info.eu@hds.com](mailto:info.eu@hds.com)

